

Building & plumbing handbook

A guide for working with
Water Corporation

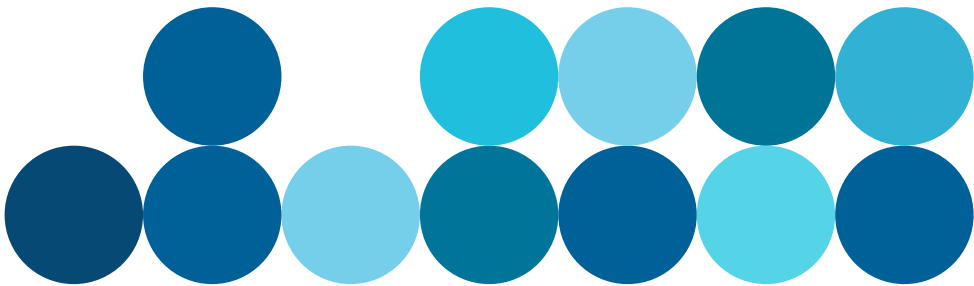

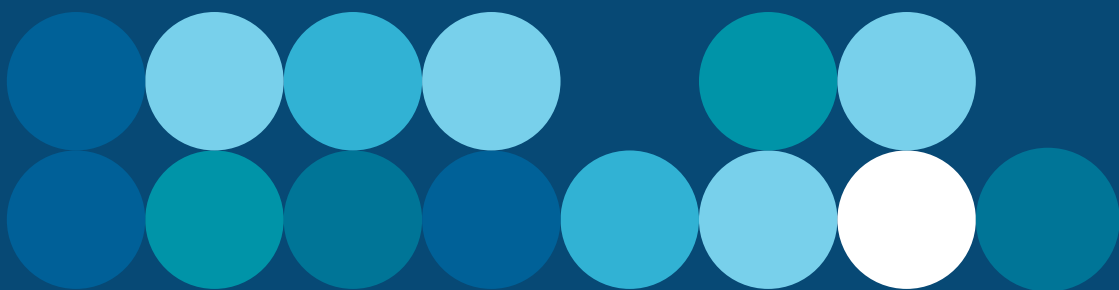

Introduction

This handbook has been produced by Water Corporation to assist builders and plumbers to work with us and our regulators to deliver the best possible outcomes for our customers, by protecting public health as well as public and privately owned assets.

Water Corporation recognises the need for government bodies, utilities and industry to work together to identify relevant areas of responsibility within the industry and the services delivered to the community.

In addition to their customer obligations, there are also statutory obligations in protecting water and wastewater infrastructure. Laws and regulations relevant to Water Corporation's operations and assets that set out these obligations are listed within this publication, as a guide to other documents that need to be understood when delivering services.

Information provided within this handbook was accurate at the time of publishing. Content updates will be made to the online version as required, which can be found at

watercorporation.com.au/plumbinghandbook

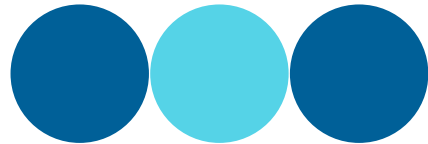



Table of contents

1	Definitions	4
2	Working with Water Corporation	5
3	Connection to Water Corporation mains	6
3.1	Water supply connections	6
3.2	Fire services	6
3.3	Flow control devices	6
3.4	Sewer connections	6
3.5	New sewer connections	7
3.6	Reporting of lost sewer junctions	8
3.7	Drainage plumbing diagrams	9
3.8	“INs and UPs”	9
3.9	Property connections to vacuum wastewater systems	9
4	Backflow prevention	10
4.1	What is backflow?	10
4.2	Backflow Prevention Policy	10
4.3	New developments, redevelopments and changed services	10
4.4	Backflow prevention device	11
4.5	Backflow regulations and standards	12
4.6	Ongoing backflow device maintenance	13
4.7	Submitting the backflow device test report	13
4.8	Backflow Smart Testers Program	13
5	Interpretation of Water Corporation DYBD plans	14
5.1	Water DYBD plan	14
5.2	Sewer DYBD plan	14
6	Disconnection from Water Corporation mains	15
6.1	Water supply	16
6.2	Sewerage	17
7	Maintenance work	18



8 Trade waste	20
8.1 Applying for a Trade Waste Permit	20
8.2 Retail food industry	20
8.3 Grease arrestor and other pre-treatment requirements	20
8.4 Sizing of grease arrestors	21
8.5 Shared grease arrestors	22
8.6 Non-typical grease arrestors	22
8.7 Pre-treatment requirements for other industry types	23
8.8 Discharge restrictions	23
9 Development Issues	24
9.1 Isolation of internal lines	24
9.2 Strata schemes	25
9.3 Metering	26
10 Buildings	28
10.1 Proposals to construct, demolish or alter buildings	28
10.2 Sewer main alignments	29
11 Electrical risks	30
12 Partnering with Water Corporation	32
12.1 Waterwise Plumbers	32
12.2 Backflow Smart Testers Program	32
13 Legal obligations	33
14 Appendix	35
14.1 Fire service configurations for backflow protection	35
14.2 Backflow boundary protection diagrams	36
15 Contact us	37



1 Definitions

Licensed plumbing contractor

A person who holds a plumbing contractor's licence under the Plumbers Licensing and Plumbing Standards Regulations 2000.

Licensed tradesperson

A person who holds a tradesperson's licence under the Plumbers Licensing and Plumbing Standards Regulations 2000.

Licensed tradesperson (drainer)

A person who holds a tradesperson's (drainage plumbing) licence under the Plumbers Licensing and Plumbing Standards Regulations 2000.

Drainage plumbing diagrams (flimsy)

Drainage plumbing diagrams (formally known as an as-constructed diagram or flimsy) are a diagrammatic representation of drainage plumbing work within a property and are certified by a licensed plumbing contractor. The contractor is legally obliged to provide the Department of Mines, Industry Regulation and Safety – Building and Energy Division (Building and Energy) with the drainage plumbing diagram.

Dial Before You Dig plans

A Dial Before You Dig plan is an extract from Water Corporation's mapping system which contains detailed information about water, wastewater and drainage mains. Dial Before You Dig plans are used by licensed plumbers when they need to locate sewer connection points.

Property sewer

A conduit laid, wholly or partly at the expense of the property owner, entirely within the boundaries of the lot, for the carriage of sewage or wastewater to any Water Corporation sewer.

Sewers

A conduit laid for the carriage of sewage or wastewater. This term does not include a property sewer. If not specified this means a Water Corporation sewer.



2 Working with Water Corporation

Land owners proposing a building development or connecting to Water Corporation water, sewer or drainage lines are required by law to make an application to Water Corporation. Applications can be lodged online via BuilderNet®

BuilderNet®

BuilderNet®, our online lodgement system, is the quickest and easiest way to lodge:

- building applications (including sewer connections)
- water service application
- sewer applications
- requests for Dial Before You Dig plans.

BuilderNet® is available free of charge, with the exception of standard Water Corporation fees and charges applicable to building and service applications.

Please refer to Section 3-Connection to Water Corporation mains (page 6), for further information about pre-connection requirements.

Building applications

Request quotations and approvals for:

- minor plans for non-habitable structures (e.g. swimming pools, garages and sheds greater than 40m²)
- alterations or additions to existing buildings
- multi-residential or commercial developments (including associated water service connections and sewer junctions).

Note: These requests are typically submitted by builders, hydraulic consultants and architects.

Water and sewer applications

You can also request the following:

- new water meters or services (e.g. fire services, temporary services and sub-meters)
- work on existing water meters or services (e.g. relocations, modifications, disconnections)
- new sewer junctions
- work on existing sewer services (e.g. alterations to access chambers, cutting and sealing pipes, and installing spigots)
- sewer conversions and connecting properties to sewers.

Note: These requests are typically submitted by builders, plumbers, consulting engineers and developers.

Dial Before You Dig plans

Dial Before You Dig (DBYD) plans can be obtained via Dial before You Dig for most properties and are provided electronically in PDF format.

DBYD plans show the location of water and sewer mains, system connections and other Water Corporation infrastructure near properties. They are useful to licensed plumbers, surveyors, developers, builders, consulting engineers, hydraulic consultants, architects, local government officers and real estate agents.

BuilderNet registration

Go to buildernet.watercorporation.com.au select 'New Registered User' and complete the form. Registration is required for customers that intend to use the system on a regular basis.

For further information, visit the website or contact **13 13 95**.



3 Connection to Water Corporation mains

It is an offence to interfere with, alter or connect to a Water Corporation water or sewer main without prior approval from Water Corporation.

3.1 Water supply connections

Connections to Water Corporation mains are provided by a meter and builders standpipe, which must be installed by Water Corporation.

Missing or damaged meters or damage to water services or pipe work must be reported to Water Corporation on **13 13 75**.

3.2 Fire services

Fire Services are provided solely for the purpose of firefighting and testing of firefighting equipment. Under no circumstances is a fire service to be used for any unauthorised purpose such as washing down trucks and driveways or connecting a domestic supply (including reticulation) via the fire service.

If a plumber has identified a cross connection, they must advise the customer that water use from a fire service for purposes other than firefighting is illegal.

Fire services are subject to backflow protection requirements (see Section 4) and are provided under an agreement.

3.3 Flow control devices

Flow control devices (FCDs) have been installed in water services for all commercial and multi-residential developments.

The device limits the water supply flow rate to the flow applied for and what has been paid for through infrastructure contributions.

Note: FCDs control the rate at which the water is supplied to a property and will not reduce water pressure. A pressure reducing valve (PRV) is required for this. FCDs are located on the downstream face of a meter and it is the plumber's responsibility to ensure that it remains in place when the internal pipework is fixed to the meter.

It is an offence to tamper with a meter, including the removal of the FCD. FCDs may be the cause of a flow lower than is required by the property owner. In this case, the customer will need to apply for a higher flow and pay the appropriate infrastructure contributions.

FCDs can potentially cause turbulence that affects the accuracy of turbine type meters, which are generally larger than 40mm. To minimise the risk, the FCD must be placed a minimum of one metre from the meter. Prior to making an application for a water supply connection, the builder/plumber must ensure there is adequate space between the property boundary and the building to install the necessary pipework to accommodate the spacing between the FCD and the meter.

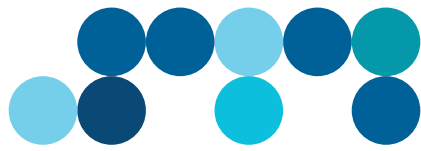

3.4 Sewer connections

Connections to Water Corporation sewer mains are provided via a connection point, which must be installed or supervised by a Water Corporation representative. It is an offence to connect private plumbing work to this connection point without approval. There is a risk to lives and health if the correct precautions are not taken.

In addition to obtaining Water Corporation approval to connect to sewer mains, licenced plumbers are required to adhere to Plumbers Licensing Board (PLB) requirements. Please visit the Building and Energy website for further information.

It is essential that the licensed plumbing contractor/builder confirms there is adequate fall to the sewer main prior to starting building construction. The conditions a builder must comply with are included with the approval.

Other important requirements are:

- confirm location of the sewer connection point
- provide for overflow relief
- Water Corporation access chambers must be kept clear for ease of access
- maintain minimum cover levels on Water Corporation sewer mains
- exercise caution when changing site levels
- verify the location of existing pipe work prior to construction or connection
- obtain separate approval where industrial or commercial waste will be discharged (see Section 8)
- provide backflow prevention devices for specified industrial and commercial developments (see Section 4).



Typical flow control devices, image courtesy of Maric Flow Control

3.5 New sewer connections

Construction of the property sewers within a property is the responsibility of the land owner. In those situations where a new sewer connection point (sewer junction) is cut into a sewer main it must be installed or supervised by a Water Corporation representative.

It is the responsibility of the licensed plumber to:

- ensure an application has been lodged and payment made to Water Corporation for the connection
- excavate to the sewer and make the site safe for one of our representatives to cut in the sewer connection
- construct the property connection into the property boundary
- provide as-constructed information showing 'ins and ups'. (Refer to Section 3.8 for further detail)
- show all boundary traps and other fittings
- ensure that the property connection (junction) is greater than or equal to the diameter of the internal property sewers connection to it.



Boundary/running traps

Boundary traps shall be installed on all property connections where the junction is located on:

- sewers that are 300mm or larger in diameter
- IO or IS sewers where the downstream sewer is 300mm or larger in diameter
- any Water Corporation sewers, regardless of diameter, that conveys a pumped discharge.

As per Water Corporations design standards, and the applicable Australian Plumbing Standards.

For further information about the provision of boundary traps on property connections please contact Water Corporations Building Services on **13 13 95**.

Gullies in flood prone areas

All external gullies in flood prone areas, including the North West Region (26 degrees south of the Earth's equatorial plane), must be fitted with "pop up" covers.

3.6 Reporting of lost sewer junctions

The builder/plumber is required to confirm the location and depth of a sewer connection point prior to work on-site commencing. Water Corporation provides a diagram showing the location of sewer connection points (junctions) at the time an application to connect is made.

When establishing the position of the connection point, care must be taken where the connection is relatively long or where there are "in and up" measurements provided.

On occasions licensed plumbers experience difficulty in locating the junction, see section 5 for information on how to interpret Water Corporation plans. The following explains the process and any pre-requisite actions for reporting a lost sewer junction.

Prior to reporting a lost junction, the licenced plumber must confirm that:

1. there is a valid and current approval from Water Corporation to connect to the sewer
2. they have the name of the licensed plumber responsible for the site
3. they have excavated at least 1 metre either side of the given measurement and 0.6 metres deeper than the depth established from the DBYD plan.

Note: Report of a lost junction will only be accepted from the licensed plumber responsible for the site.

- All reports shall be made by contacting Water Corporation on **13 13 95**.
- You will be asked to confirm that the prerequisite steps have been undertaken.
- You will be required to accept that Water Corporation may seek to recover any costs should the junction be located within the correct limits.
- Where the excavation can be safely secured, you will be required to do so pending resolution.*
- Where the excavation cannot be secured, you will be required to backfill.**
- You will be advised at the time of making a report of the likely resolution date.

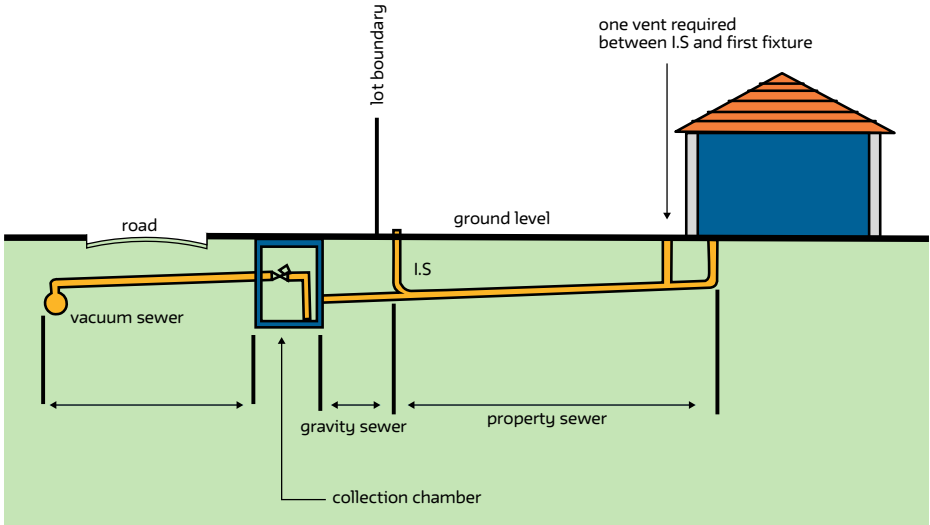

- Water Corporation will not be able to assist if the plumber/builder has not followed this process, or there is no record of a current application to connect to the sewer – and or a copy of the plan is not available on site.

*The licensed plumber is responsible for the safety of site excavations at all times.

**Prior to backfilling the excavation it is recommended that photographs are taken to support of your Lost Junction Report.

3.7 Drainage plumbing diagrams

Please refer to the drainage plumbing guidance note on the Building and Energy website for further information on Drainage Plumbing diagrams.

3.8 “INs and UPs”

Measurements

Where the property sewers (property connection) has been brought into a property the as constructed sketch must include IN and UP measurements from the centerline of the sewer main to the connection end points within the property (refer to section 3.4).

3.9 Property connections to vacuum wastewater systems

The Australian Standard AS/NZS 3500:2003 Part 2 Clause 3.18 specifies installation requirements. Licensed plumbers are expected to be aware of these requirements.

Note: Vacuum sewer schemes may have a restricted capacity. If you intend to connect anything other than a single residence, such as commercial or industrial properties, to a vacuum wastewater system you should obtain advice on **13 13 95**.

The diagram above illustrates a connection where the collection chamber is located outside the property boundary.



4 Backflow prevention

An ongoing threat to the quality of Water Corporation's drinking water supply is the flow of water backwards from a customer's property through their property's water service connection (fire services included).

This water may be contaminated by the activities within the property, and may cause death, health problems or an inconvenience to persons ingesting or using the water.

4.1 What is backflow?

Backflow is the reversal of the normal direction of water flow in a water supply plumbing system. It occurs when the water delivery main is at a lower pressure than the internal plumbing system (backsiphonage). Backsiphonage can occur when there is a burst or ruptured water main, or when there are periods of high demand. Excessive demand during fire fighting operations can also result in backsiphonage.

Backflow can also occur if a water pump (such as a bore pump) is cross connected to the internal water plumbing system, and is pumping bore water at a higher pressure than the water mains pressure (backpressure).

If a property's drinking water supply is inadvertently interconnected with a source of pollution, either through a cross connection or simply a hose submerged in a container of liquid, then these pollutants could enter the water supply when there is an overpressure on the private property side or a sudden drop in water mains pressure.

4.2 Backflow Prevention Policy

Water Corporation's Backflow Prevention Policy requires the installation of approved backflow prevention containment devices at the boundary of every water service

connection to a property (including fire services). At this point, fire services that were installed prior to May 2010 are not required to install a boundary device unless the fire service is being altered at the property boundary. This policy is supported by relevant legislation and plumbing standards.

4.3 New developments, redevelopments and changed services

At the time of building approval, development application, redevelopment or changes to existing water services, the applicant will be informed of the property's risk rating.

The following building application types will be assessed for backflow risk:

- new developments
- redevelopments of existing facilities
- changes to any existing water service
- additions/alterations (including where no water service applications are included, applicable only if the property has existing meters)
- multiple residence and/or commercial (includes where no water service applications are included, applicable only if the property has existing meters)
- any applications that involve a fire service
- any applications where the minimum water service size applied for is greater than 25mm in size (except fire services, where the backflow advice applies regardless of the service size).

Building application approvals also include:

- a backflow approval sticker as part of the approved site plan document



- the applicable backflow information sheet (directed towards the applicant), based on the assessed backflow risk (high, medium or low); and
- Plumber's information sheet (designed for the applicant\ to provide to their nominated licensed plumbing contractor and/or hydraulics consultant).

Site-specific activities will determine the final level of backflow risk and for certain commercial and industrial processes may default the property risk rating to high.

If a property owner considers the risk rating assigned to their property is higher than the risk of activities being carried out, then the property owner may appeal this rating.

The property owner must consult a suitably qualified licensed plumbing contractor or hydraulic consultant first, and submit an appeal form to Water Corporation within 28 days of receiving risk rating advice. Water Corporation will advise the property owner of the outcome of the review.

- The risk rating of a property determines the minimum requirement for the type of backflow prevention device(s).
- Irrespective of the risk rating of a property, all fire services are rated medium risk and require (as a minimum) a medium rated device to be installed.
- If the future land use is unknown, the risk rating will default to high.
- Where there is mixed use on a property, the risk rating will default to high.
- Changes in the activities within a property can result in a change of the backflow risk rating and the backflow device(s) required.

4.4 Backflow prevention device

The containment backflow prevention device must be installed on the customer's side of the water connection at the property boundary, and belongs to the owner of the property.

The installation of a containment backflow prevention device does not eliminate the need for zone and individual backflow prevention devices that may be required under plumbing standards. Water Corporation does not manage zone or individual backflow protection.

All backflow prevention devices that are installed at the boundary must be registered. This information should be submitted to Water Corporation by a licensed plumbing contractor qualified to test the devices no later than 5 working days after the test is carried out.

The following conditions should be noted:

- Boundary containment backflow prevention devices are required to be installed as part of the plumbing system downstream, and as close as practicable to the property's water meter (or property boundary if no water meter is available). Refer to the Appendix on pages 35 and 36.
- No connections are permitted between the meter outlet and the containment device.
- If continuity of supply is critical to your client, consideration should be given to connecting duplicate devices in parallel.
- If the property has more than one water service, you will need to install a device/s at the connection point for each of those services.



- All fire services are rated as medium risk, and the installation of a medium risk rated device is required, as a minimum (excludes fire services installed prior to May 2010).
- The installation of some forms of backflow prevention devices will reduce water pressure/ flow rate downstream of the device. If the water pressure and/or flow rate is critical to your client, then this should be discussed with your client prior to choosing and installing the final backflow prevention device.

Work related to the installation of backflow devices is identified as plumbing work and is therefore covered by the Plumbing Regulations. Compliance with the plumbing standards will therefore be monitored by the PLB; you are required to notify the PLB of your intention to carry out the work.

Only licensed plumbers who are qualified to install, test and certify backflow prevention devices are permitted to carry out such works.

Water Corporation will inspect properties to ensure ongoing compliance with its Backflow Prevention Policy.

4.5 Backflow Regulations and Standards

Water Corporation requirements relating to the installation, maintenance and testing of a backflow prevention device are supported by legislation and plumbing standards.

Regulations for backflow prevention

The requirement to have and maintain backflow prevention devices at the boundary of a property is supported by legislation, including the following regulations:

- Regulations 42 and 43 Water Services Regulations 2013

Due to the potentially serious nature of a backflow incident, Water Corporation can in accordance with these regulations serve an order on a property owner or occupier to install backflow devices.

The regulations also provide for penalties for non-compliance under the *Water Services Act 2012 (WA)*. Water Corporation has the power to restrict or disconnect water services, to protect the drinking water supply from potential contamination caused by a backflow event from a property.

Standards for backflow prevention

In addition to all plumbing regulations, licensed plumbing contractors must also apply the following standards for backflow prevention:

- AS/NZS 3500:2018 Plumbing and drainage Part 1: Water Services.
- AS/NZS 2845:2010 Water supply-backflow prevention devices Part 1: Materials, design and performance requirements.
- AS 2845:2010 Water supply-backflow prevention devices Part 2: Air gaps and break tanks.
- AS 2845:2010 Water supply-backflow prevention devices Part 3: Field testing and maintenance.



4.6 Ongoing backflow device maintenance

Testable backflow prevention devices at the property boundary must be installed on high or medium risk properties. These require testing;

- at commissioning, after any maintenance
- every 12 months by a licensed plumbing contractor, permitted to test the devices.

Water Corporation will send an annual reminder letter to the property owner for these boundary devices. Failure to maintain a backflow device will result in the serving of a non-compliance notice to the property owner or occupier.

Backflow test reports must be submitted online to Water Corporation no later than 5 working days after the test is carried out.

Water Corporation do not manage zone or individual type backflow prevention and do not accept test reports for these types of devices.

4.7 Submitting the Backflow Device Test Report

Test reports for boundary containment backflow must be submitted online.

To register for online lodgement visit:

watercorporation.com.au/backflowlodgement

4.8 Backflow Smart Testers Program

The Backflow Smart Testers Program allows plumbing businesses with accredited backflow testers who have already registered, and agree to submit test reports through our web application only, to be promoted through our website. To participate in this program visit: watercorporation.com.au/backflowsmartsignup



5 Interpretation of DBYD Plans

DYBD plans are extracts from Water Corporation’s mapping system that, among other things, show the location of sewer connection points. It is essential for all plumbers to be able to interpret DYBD plans.

When using DYBD plans there are limitations in how the information may be used. Users must not rely entirely on the plan. When the information is critical, the pipe position must be physically confirmed prior to any mechanical excavation or boring.

5.1 Water DYBD Plan

The following water DYBD plan is intended as a guide.

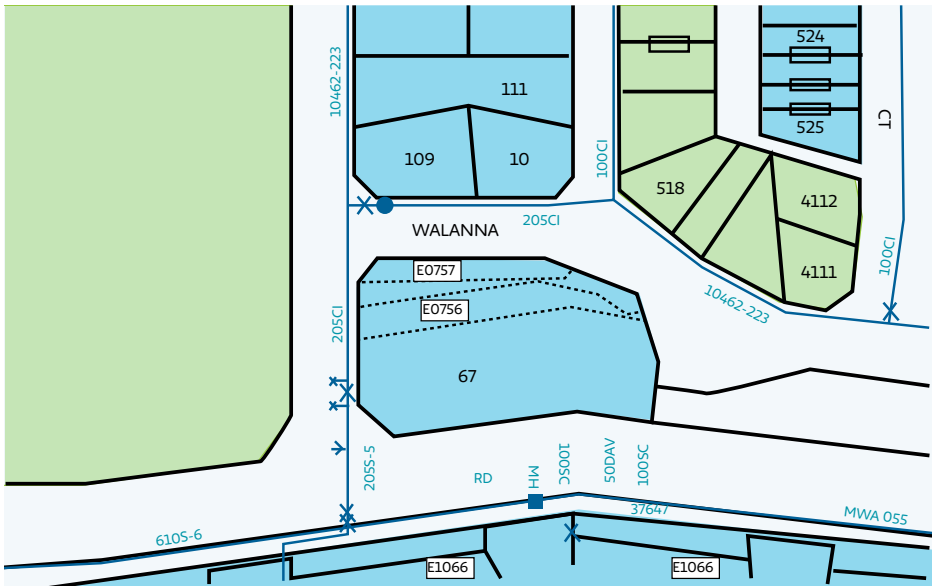

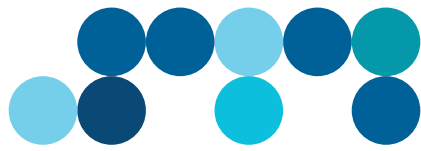

5.2 Sewer DYBD Plan

Some junctions in older areas (typically those prior to 1986) have not been brought into properties or up to one metre below ground level. Licensed plumbers must not rely on previous experience or the graphical representation of DYBD plans when locating sewer connection points.

The example below illustrates why it is necessary to accurately interpret DYBD plans. While the connection for Lot 517 is shown outside the property line, the dimensions show the connection point has been brought in **2.7 metres and up 1.9 metres** from the sewer line.

The graphic for Lot 111 reflects the measurement which indicates it has been brought **in 1.3 metres and up 1.9 metres** from the sewer line. Common in older suburbs, the sewer connection point may not be brought into the property, and it is the licensed plumber's responsibility to correctly interpret the DYBD plan.

Refer to Section 10.3 for direction on how to estimate depths to Water Corporation sewer pipes. The following sewer DYBD plan is intended as a guide:

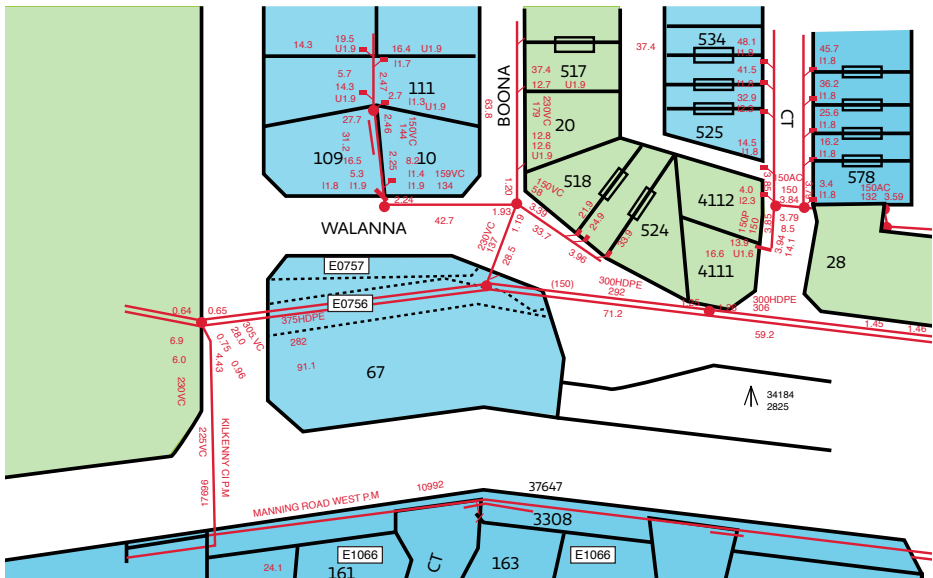



6 Disconnection from Water Corporation mains

6.1 Water supply

Before the demolition of any building, the landowner is required to notify Water Corporation prior to the demolition commencing (Water Service Act 2012 Section 82).

Once the demolition has taken place, if there are no immediate plans for further development at the property, Water Corporation may require the meter to be disconnected to reduce the risk of damage, theft, wasted water or contamination of the water supply.

Where further development is planned, the water meter may remain on site, subject to the installation of a standpipe by a licensed plumber, compliant with AS/NZS 3500: 2018.

Where a landowner chooses to leave the water meter on site, they will be responsible for any damage to the water service or water theft.

The diagram below illustrates how the connection for a temporary standpipe may be made.

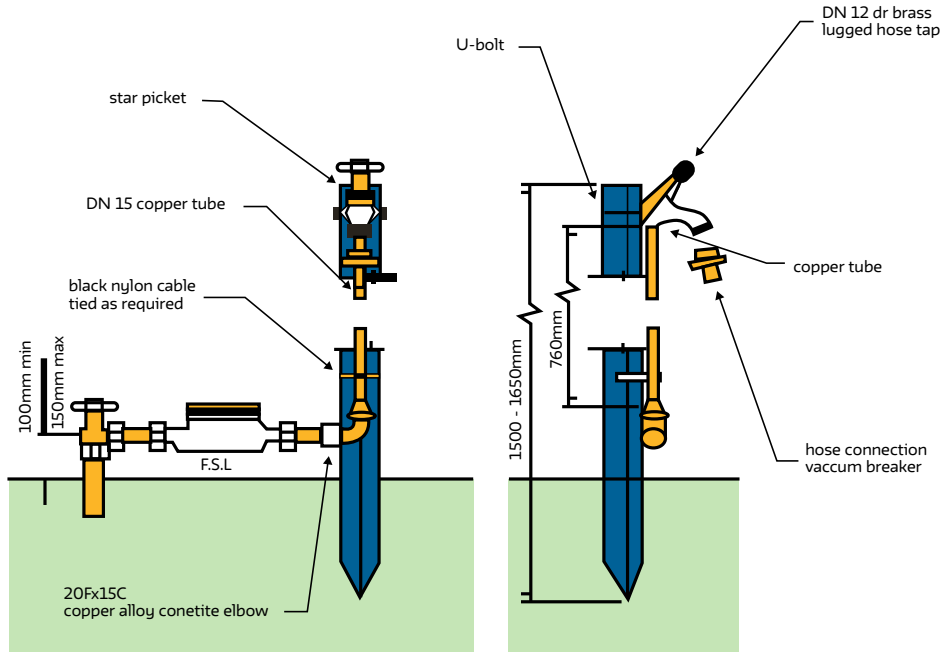



6.2 Sewerage

Prior to the demolition of any building the landowner is required to engage a licensed plumber to disconnect the building from the sewer main and ensure the sewer connection point is left sealed, compliant with the relevant plumbing standards. Refer to the Building and Energy website for more information.

The diagrams below illustrate correct sewer disconnections.

Note: Drains shall be sealed using approved methods as listed in AS/NZS 3500: 2018.

Inspection shaft rising shaft

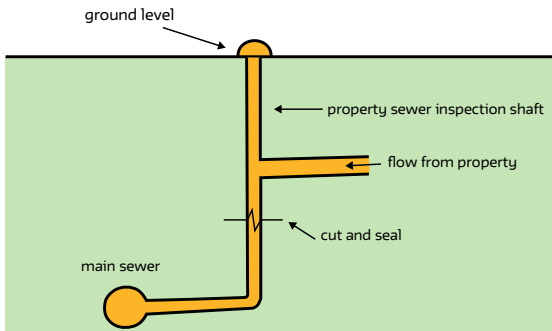

square on back

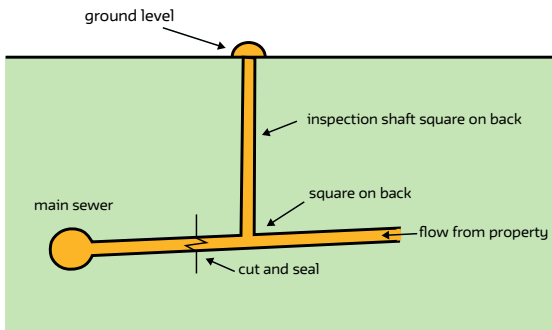



7 Maintenance work

This section provides guidelines for customers and licensed plumbers relating to maintenance responsibility for blockages in property sewers. The sewer property connection is the pipe between the inspection shaft and the junction on the Corporation's sewer main, shown as A and B on the below diagram.

The guidelines ensure that property owners will not be responsible for excavation to excessively deep sewers or for excavation in another property. They apply to the inspection shaft (IS sewers), long sewerage connections and jointly used main drains (other than in strata schemes).

1. Property owners are responsible for the cost of clearing any blockage in their sewer property connection, where the blockage can be cleared from the inspection shaft.

2. Property owners are responsible for the cost of any CCTV requirements where the CCTV is initiated by a licensed plumber.

Water Corporation will not reimburse licensed plumbers for clearing any blockage where it is found to be in the property connection, and will subsequently clear it from the inspection shaft.

3. If Water Corporation determines that an excavation is required to repair the sewer property connection, the Corporation will assist the plumber when:

- the depth of the required excavation is 2.5 metres or more
- excavation is required outside the property.

The diagram below illustrates the intent and interpretation of this application.

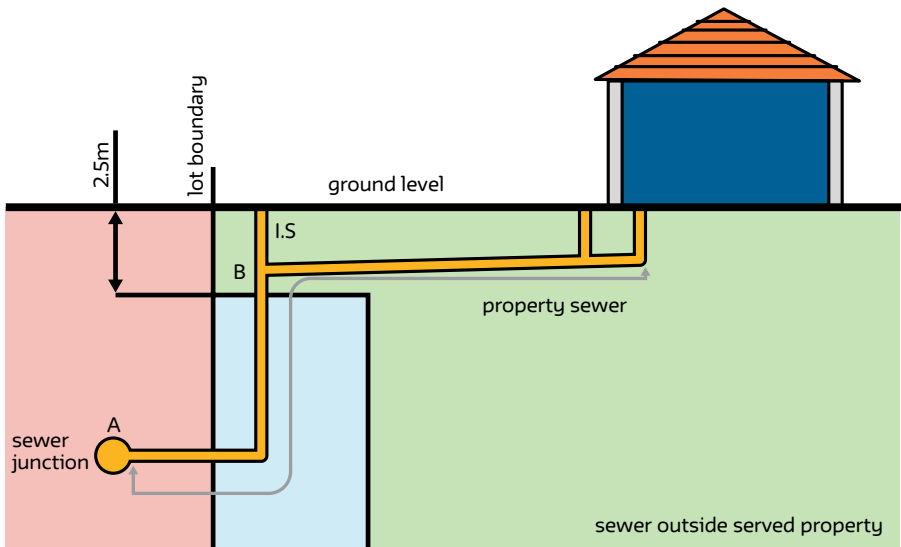



Detailed below is the process to be followed when plumbers become aware of a blockage in a sewer connection, where it fits the circumstances outlined on (page 28):

1. Contact Water Corporation's Service Faults and Emergency number on **13 13 75**.
2. Advise the customer service representative of the situation.
3. Obtain a work order number from the customer service representative. Keep a record of the number.
4. Invoice Water Corporation referencing the work order number.
5. Water Corporation will pay the licensed plumber a standard fee, as agreed with the plumbing industry. The fee is intended to cover travel costs and the onsite assessment. Water Corporation expect that no costs will be borne by the property owner.



8 Trade waste

Trade waste or industrial waste is any wastewater discharged from business other than waste from office facilities or staff amenities.

If disposing trade waste into our wastewater system, business operators are legally required to have a trade waste permit. If the wrong waste goes down the system, it could cause serious harm to public health and the environment.

8.1 Applying for a Trade Waste Permit

Complete a trade waste application form, along with any relevant supplement forms and submit to Water Corporation with site hydraulic drawings (plumbing design drawings) for assessment prior to commencing any discharge of trade waste. See watercorporation.com.au for an application and supplement forms.

8.2 Retail food industry (for all other industry type requirements, see section 8.7)

The grease and fat contained in wastewater can accumulate both in your drains and our wastewater system, resulting in odorous and toxic gases, corrosion, blockages and wastewater overflows.

Blockages and overflows impact the community and our ability to provide customers effective wastewater services. Under the *Water Services Act 2012*, all businesses involved in the retail food industry must obtain written permission in the form of a trade waste permit before discharging any waste into our wastewater system, and comply with all permit conditions including the installation or upgrade of a grease arrester.

8.3 Grease arrester and other pre-treatment requirements (for the food industry)

During the trade waste application assessment process, our trade waste officers assess if a grease arrester is required based on the type of activities being undertaken. In general, retail food businesses that prepare and cook on site require a grease arrester.

The list below shows typical pre-treatment requirements for different types of retail food businesses.



Minimum pre-treatment required	Examples of typical business	
Installation of a Water Corporation accepted grease arrestor	Cafes, restaurants Lunch bar, deli Takeaway shops Fish and chips Kebab shops Butcher shops Bakeries	Function centres Taverns/hotels Quick service restaurants Catering establishments Food manufacturing School canteens
Installation of a Water Corporation accepted In-sink and floor strainer units	Childcare centres Fish retail (wet processing) School canteen (no cooking) Bakery (bread only, no pies or cakes)	Takeaway pizza only (No other type of food prepared on site) Donut shop

Only pre-treatment devices, which are accepted for use by Water Corporation should be installed and connected to the sewer. For more information on pre-treatment products visit: watercorporation.com.au/pretreatmentproducts

8.4 Sizing of grease arrestors

The size of a grease arrestor is critical in ensuring the wastewater discharged from a greasy waste producer has the optimum conditions for efficient suspended solids, oil and grease removal.

Two methods can be used to determine the appropriate size of a grease arrestor. Both are based on ensuring the wastewater has a minimum retention time of one hour.

Note: Water Corporation has a minimum grease arrestor size of 500 litres and a maximum size of up to 10000 litres. Although grease arrestors larger than 2000 litres have been approved for individual use by the Water Corporation, these are not approved to be used

in series. The maximum allowable units in series are two (2) units and the total maximum allowable capacity of any units in series is therefore 4000 L (2x2000L). Customers wishing to install these larger grease arrestors should seek our approval before installation.

Peak flow rates method

Where the hourly peak wastewater flow rate is known, it can be used to determine the recommended grease arrestor size. Compare the peak hourly flow with the 'Calculated Grease Arrestor Size Range' in Table 2 to determine the corresponding 'Minimum Grease Arrestor Size'.

Fixture unit rating method

Add the fixture unit ratings (see Table 1) for all fixtures that feed into the grease arrestor and multiply this by 100L. Check where this calculated volume lies in the 'Calculated Grease Arrestor Size Range' (Table 2 below) to determine the corresponding 'Minimum Grease Arrestor Size'.



Fixture unit ratings - Table 1

Fixture	Fixture Unit Rating	Fixture	Fixture Unit Rating
Steamer	1	Kitchen sink	3
Wok (per burner)	1	Double kitchen sink	3
Hand Basin	1	Pot sink	5
Rinse sink	3	Double pot sink	5
Combi Oven	5		

Recommended grease arrestor sizes - Table 2

Maximum Number of Fixture Units	Calculated Grease Arrestor Size Range (litres)	Recommended Grease Arrestor Size (litres)
7	100 - 700	500
13	701 - 1300	1000
17	1301 - 1700	1500
26	1701 - 2600	2000
52	2601 - 5200	2 x 2000, 4000
78	5201 - 7800	6000

8.5 Shared grease arrestors

Water Corporation will only approve shared tenancy grease arrestors when the property owner or the owner's designated agent (such as a shopping centre manager), agrees to take responsibility, and applies for a trade waste permit.

In circumstances where Water Corporation approves businesses to share a grease arrestor, the minimum size can be calculated using either method. If using method one, the combined fixture unit rating of all businesses sharing the grease arrestor must be used. The minimum size for a shared arrestor is

1000 litres. Where the fixture unit loading is too high for a single grease arrestor, and it is not practical to connect grease arrestors in series, the waste streams are to be split, and diverted to individual grease arrestors to accommodate the fixture loadings.

8.6 Non-typical grease arrestors

Water Corporation may accept the use of other types of grease arrestors, such as those that may include the use of filters. These types of grease arrestors may be subject to specific conditions or use restrictions. It is recommended that prior to the installation of such arrestors, customers seek advice from us.



8.7 Pre-treatment requirements for other industry types

Most trade waste discharges to sewer will require some form of pre-treatment. For example, businesses such as, mechanical servicing, vehicle/plant washing, fuel stations, etc. that generate oily wastewater discharge, will require an oil/water separator. These come in various types such as the Coalescing Plate Separator (CPS) Vertical Gravity Separator (VGS) or Hydrocyclone.

For these and other types of approved pre-treatment products, that may be applicable to your business, visit: watercorporation.com.au/pretreatmentproducts

Typical drawings of pre-treatment apparatus are also available on Water Corporation website. More complex wastewater may require the producer of the waste to engage a wastewater treatment or plumbing consultant, to design a suitable treatment system to meet our acceptance criteria.

Only pre-treatment devices, which are accepted for use by Water Corporation, should be installed and connected to the sewer. Always check with your supplier prior to purchasing any pre-treatment product.

8.8 Discharge restrictions

Dishwashers and glasswashers

Dishwashers and glasswashers are **not** to discharge into grease arrestors, due to their use of detergents, high water temperatures and surge loads. This can overload the arrestor or can liquefy or emulsify oil and grease, allowing it to be discharged to sewer.

Swimming pools

Backwash and drainage from domestic swimming pools and spas are not considered as trade waste and are not permitted to be discharged to sewer. For disposal options, please contact your local council. Backwash and drainage from "Aquatic Facilities" as defined in *Health (Aquatic Facilities) Regulations 2007 (WA)* must apply for a Trade Waste Permit prior to connection to sewer and meet all applicable trade waste policies.

Storm water

Storm water from domestic or commercial premises must not be connected or discharged to the sewer as it is considered a prohibited discharge.

Food waste disposal units (garbage grinders)

The installation of garbage grinders on any service connected to the sewer is prohibited.



9 Development issues

Licensed plumbers need to be aware that issues affecting plumbing work may arise during the development of land.

A development of land includes:

- amalgamation by subdivision of two or more lots
- any green title or strata subdivision
- any building on a land parcel.

The main areas that plumbers should be aware of are:

- internal sewer or water lines that extend into another lot when a lot is subdivided
- water meters located in a new lot separated from an existing house
- sub meters that may be required on a multi-residential development or strata scheme.

Plumbing should be rationalised for any development, to minimise the number of meters and sewer connection points. This makes the property easier to manage and may reduce the annual service charges for the land.

9.1 Isolation of internal lines

At the time of subdivision, internal water or sewer lines may be isolated from the building they are servicing. The problem is more severe if the sewer connection point or the water meter is isolated, as illustrated in the Isolation of internal lines diagram (on page 25).

An example on the next page highlights where a single lot was subdivided into two, existing internal water and sewer lines extend into the new Lot 2. Prior to the subdivision being finalised, it is necessary to provide a new sewer connection point at B and realign the sewer line going to A, so it is entirely within the new Lot 1 to a new connection point at B.

The water connection point at X would need to be relocated to Y and an additional meter provided for in the subdivision process.



Isolation of internal lines

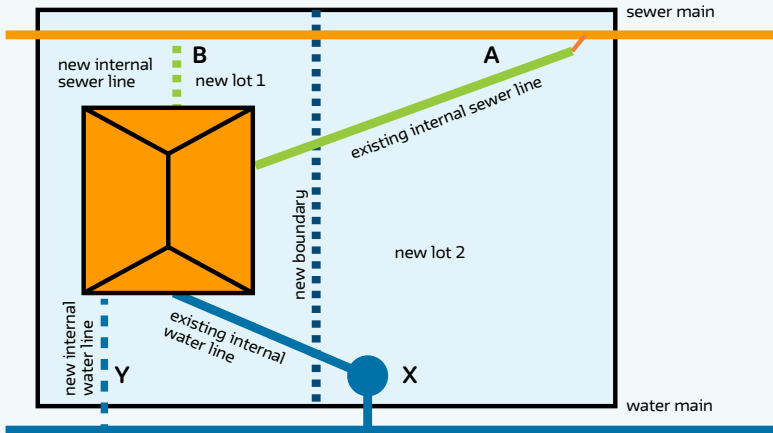

9.2 Strata schemes

Through the strata subdivision process – Water Corporation will ensure that access to our services is available at the boundary of the Strata Scheme in accordance with our Water Services Licence requirements and servicing standards. The developer is responsible for ensuring that all lots proposed under the Strata Scheme have adequate access to these services, and that any existing plumbing is adequately protected.

Refer to the *Plumbers Licensing Boards Technical notes on Survey Strata Lots* for further information on strata schemes.

In order to do this the developer may choose to install dormant plumbing (water and sewer) and/or relocate any existing internal plumbing.

Dormant sewer or water lines are a section of internal plumbing laid in the ground for future connection of a building to the sewer or water mains. Dormant lines may be laid during the development of the strata to avoid the need for strata neighbours to intrude upon each other to install the lines after the scheme is established.



9.3 Metering

Access

Water Corporation is the owner of the meters and associated fittings. It is illegal to tamper with any part of the meter and customers have an obligation to maintain 24/7 clear access for the meter to be read and replaced.

Multi-unit developments

There are two metering options available to all residential properties and non-residential strata properties that require metering at an individual unit level:

1. Fit individual meters at an agreed road frontage adjacent to a water main for individually subdivided, or strata titled lots.
2. Fit a master meter at an agreed road frontage adjacent to a water main which connects to sub-meters via private internal plumbing.

For all sub-meter installations, the work must comply with the standards and instructions issued by Water Corporation at the time of the work being carried out.

Water Corporation is responsible for maintaining the sub-meter and tails. The strata company is responsible for all internal pipework which must be undertaken by a licensed plumber.

Further information about the installation requirements and application process can be found at *Water Corporation > Applying for Services*.

Above ground meter installation clearance distances

- As a safety requirement, bridging cable (earthing strap) must be attached onto the vertical copper pipe on both ends of the meter assembly.
- Vertical pipework is not to be set in concrete, brick paving, bitumen etc, as some flexibility in the pipework is required for meter replacement.
- Water Corporation personnel must have access to meter assembly at all times.
- PVC and/or MDPE (plastic) fittings or pipe, if used, must be at least 225mm below ground level.
- The clearances shown here are required to facilitate meter reading and/or replacement when required. This is a requirement under Water Services Regulations 2013, N23.

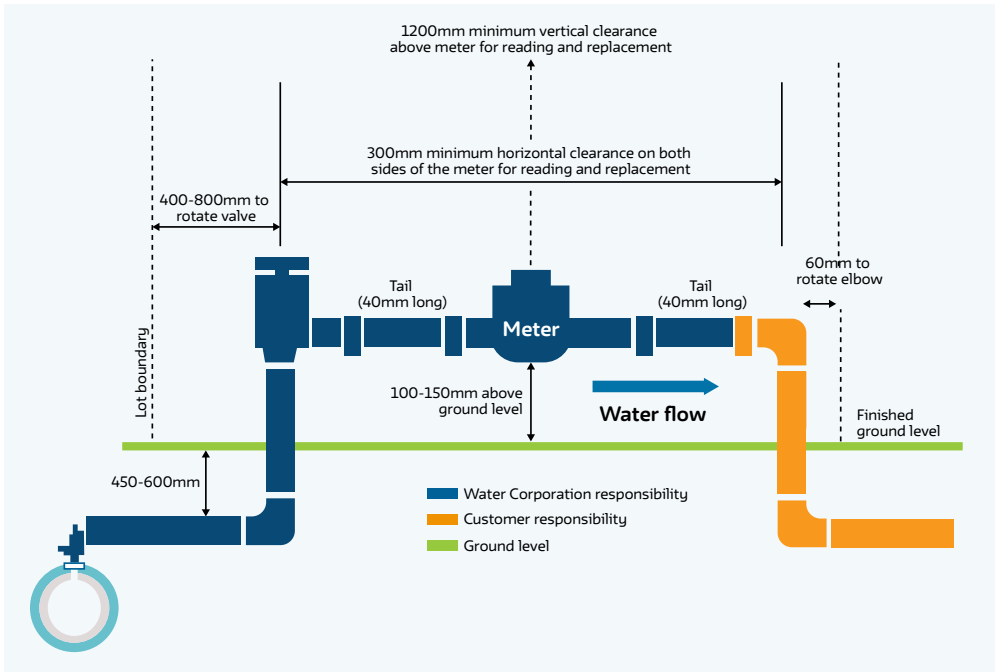

20mm Water meter assembly requirements

Note: Water Corporation does not have control over what the plumbing industry can install and can only apply its specifications and requirements when asked to take over the metering for the property.

- Existing installations are likely to be fitted with a stopcock.
- All new 20mm installation are being fitted with the right angle ball valve. For properties with multi metering arrangements, Water Corporation is only responsible for tail to tail assembly.
- No branch or fitting to be connected within one metre (1,000mm) from valve.

Installing meters below ground level in a box

Currently only one meter box has been assessed by Water Corporation as acceptable:

- **METER BOX MMR 21099**, Service Box, Meter, Supplier – Stockbrands Co Pty Ltd, 53 Edward St, Osborne Park, WA 6017.
- **D1200 METER BOXES** are not acceptable.



10 Buildings

10.1 Proposals to construct, demolish or alter buildings

Any person proposing to build, demolish or alter any building or construction activity in an area served by a Water Corporation water or sewer main must obtain approval and pay the prescribed application fees prior to commencing construction (This is a legislative requirement under section 82(1) of the Water Services Act).

Water Corporation provides guidance for single residential and some other building types. Builders must refer to our *Residential Guidelines for Designers* document to assist with the self-assessment of design prior to lodgement of an application.

The self-assessment allows you to identify the requirements to protect our sewer assets from the effects of building and construction activities. It is intended to maintain adequate access to Water Corporation sewer assets whilst assisting the protection of your proposed works from any future damage.

The *Residential Guidelines for Designers* can only be applied to the following building or construction activities within the prescribed proximity of our sewer mains:

- single residential buildings
- single storey addition/alteration to existing residential buildings
- below ground swimming pools, spas or tanks
- sheds
- retaining walls.

For any other building and construction activities not listed above, you will need to refer to our *Technical Guideline for safely working near Water Corporation assets*.

Builders and licensed plumbers working for Land Developers should also consider the following points.

1. That our water and wastewater services are adequate for the proposed building or development. In some circumstances, it will be necessary to extend or enlarge the existing network and connections to the property.
2. Wherever possible, all survey levels provided should be in Australian Height Datum (AHD) as it assists in ensuring the building can be adequately served by the sewer, and makes the design of piling easier. This is particularly important where the ground level has been altered.
3. Builders are responsible for establishing the location of sewer connection points prior to starting any works. In the event that the connection point cannot serve the proposed building, or it is not located in the correct position, the builder will be responsible for any additional works necessary. This is particularly important in the redevelopment of lots in older suburbs.
4. In some circumstances, the builder may need to have the location of Water Corporation's pipe work confirmed by survey.
5. Licensed plumbers are required by law to apply to Water Corporation prior to connecting a property to the sewer mains. On some occasions this application is made by the builder, however if in doubt licensed plumbers are advised to contact the Corporation on **13 13 95**.



6. Licensed plumbing contractors are required to submit a drainage plumbing diagram when they are the responsible person for drainage plumbing work that involves the installation, alteration or extension of drainage plumbing. Refer to the *Building and Energy Drainage Plumbing Diagram* homepage for further information.

10.2 Sewer Main Alignments

Information on Sewer Main Alignments can be found in the *Residential Guidelines for Designers* document.

Please refer to our full *Guidelines for Designers* manual for guidance to protect Water Corporation's water, sewer and drainage services, and requirements for access to those services, where building and/or construction activities are carried out in their proximity.

If you require assistance please contact us on **13 13 95** or email building.services@watercorporation.com.au



11 Electrical risks

To eliminate any potential risk caused by underground directional drilling activities into private, local government or Water Corporation sewers and drains, it's important to refer to Western Power for more information:

westernpower.com.au/safety-access/working-near-our-network/

Licensed plumbers must exercise caution when clearing blockages in or near sewer lines particularly in the front verge. The safety of plumbers is at risk if cutting tools are used to clear the blockage that is potentially caused by live electrical cables.

Power companies and their electrical contractors are required to take all prescribed precautions to prevent the cross boring of electrical cables into sewers, drains and other pipes and conduits. However, Western Power advises that live cables can often penetrate drainage pipes, storm water pipes, sewer mains and sewer connections to properties. For more information please refer to the Western Power website.

This occurs due to high boring activity levels. In some instances this may be undetected until the property owner or tenant reports and seeks to clear a sewer or drain blockage.



Warning – Licensed plumbers:

- Mechanical devices and high pressure cutters can cut into a cable, presenting a serious electric shock or electrocution.
- Never attempt to clear a blockage unless you are absolutely certain that a power cable is not the cause.
- Do not make assumptions about the installation or location of underground power cables.



Before commencing work, determine if property in the vicinity of a blockage is connected to underground power. If you are unsure, the following may indicate that an underground power cable may have caused the blockage.

What to look for at the property

- Is there a green dome on the property boundary?
- Is there an underground pit within the property or on the verge?
- Are there any signs of recent excavations?
- Does the property have overhead or underground power from the street to the building?

What to look for in the street

- Is the area serviced by underground power to either multiple or single properties?
- Are there poles with cables attached that run from the top of the pole to the ground?
- Is there a green cabinet displaying a danger warning sign?
- Are there any signs of recent excavations?

Tools and equipment

Consider the use of alternative blockage cleaning tools, such as lower pressure jet-washers. CCTV technology can also be used to positively identify the cause of blockages.



Assistance with locating underground power

Western Power on **13 13 51**

<https://westernpower.com.au/>

Horizon Power on **13 23 51**

<https://horizonpower.com.au/>



12 Partnering with Water Corporation

12.1 Waterwise Plumbers

Water Corporation has had a rewarding association with the plumbing industry through the Waterwise Plumbers program, developed in 2003.

The Master Plumber and Gasfitters Association offer a training course, endorsed by Water Corporation, for plumbers who wish to join the program. The training covers all activities related to water efficiency and plumbing.

Training includes:

What are the benefits of becoming a Waterwise Plumber?

- You will receive the most up-to-date training for yourself and/or your staff on the latest waterwise principles, practices and products. Being equipped with waterwise knowledge is both a requirement to become a Waterwise Plumber and a benefit to your business.
- Get access to exclusive Waterwise branding promoting yourself as a Waterwise Plumber and differentiate yourself from the competition.
- Being promoted by the Water Corporation as being leaders in your industry with the best waterwise service and advice, and recommended to customers when they contact us.
- We direct our customers with plumbing enquiries to the list of Waterwise Plumbers on our website. Waterwise Plumbers are also preferred suppliers for various Water Corporation programs and projects. The Water Corporation engages with our Waterwise Plumbers wherever possible for initiatives throughout the community.
- Receive promotional materials to help promote yourself as a Waterwise Plumber

12.2 Backflow Smart Testers Program

The Backflow Smart Testers Program allows plumbing businesses with accredited backflow testers who register and agree to submit test reports through our web application.

To be eligible for the Backflow Smart Testers Program, all of your certified backflow testers must also be separately registered to submit test report forms online, visit watercorporation.com.au/backflowsmartsignup.

The program advantages are:

- Registered testers will have their business details listed on our website, and will be identifiable to our customers, who may choose to engage a Backflow Smart Tester to undertake work on their behalf.
- Customers will have access to an online search tool for backflow testing companies in their area.
- Water Corporation backflow test reminder and compliance letters will refer customers to the Backflow Smart Testers Program.



13 Legal obligations

The Legal References table describes some of the responsibilities plumbers have under the following water legislation:

- Water Services Act 2012
- Water Services Regulations 2013

These requirements recognise the licensed plumber’s role in protecting water and sewerage infrastructure and ensure that the interests of all customers are protected.

Legal references

Requirement/activity	Water Services 2012	Water Services Regulation 2013
Licensed plumbing contractor to submit as constructed drawings of plumbing work to the Corporation within 5 days of completion of works	90	53
It is an offence to place anything over a pipe which affects the Corporation’s ability to inspect or maintain it		
Licensed plumbing contractor must report damage done by themselves to pipes and take steps to make repairs		51(2)
Licensed plumbing contractor to report certain matters		51(1)
Responsibility of landowners including to keep private plumbing in good order and conduct repairs or rectifications when required by the Corporation	92	
No branches or fittings to be installed within one meter of the meter		24(2)
Not more than one house can be served by a single meter unless authorized by the Corporation	125(2)	
Items prohibited to be discharged to sewer	88(1)(g)	
Requirement to lodge a building application	82(1)	
When a sewer is completed and ready to use	98	
Circumstances where costs incurred by the Water Corporation may be recovered		25(2)
Authority to enter property	140(1)	
Misuse of water	89	
Pipe not greater than 20mm		21(1)
If an applicant requires the Corporation to reconnect a disconnected service the Corporation has the right to recover the current cost of the disconnected service	95	



Requirement/activity	Water Services 2012	Water Services Regulation 2013
Fire hydrants are for firefighting only	97	
Fire hydrants to be sealed	97	
Additional services	83 & 94	
The Corporation may provide and install on a building or construction site a temporary building stand-pipe together with hose-tap and pipe connection on payment by the builder of the fee set out in Schedule C item 4	78	
Builder responsible for the security of the meter		25
An existing meter service is not to be used for a building construction until the proposed building has been approved by the Corporation	82 (1)	
Supply may be disconnected if used in connection with any work in addition to that show on the submitted plans on which the building fee was assessed	89	
Meter may be fitted at the Water Corporation's discretion (circumstances & size)		
Meters in multi residential		23(2)
Meters may be required to be installed in a pit or cubicle		22
Owners responsible for any damage to the meter and as such take care to protect and secure the meter		25(2)
Access to meters - Meters must have clear space around them. Where an owner changes the ground levels or causes other changes to the land the owner will need to meet the cost of any relocation to ensure the meter has adequate clearance and protection		24(1)
Damage to meters must be reported		25
Swimming pools not to be connected to sewer without approval	88(1)(g)	
Trade Waste Requirements	102, 103, 104, 105, 106	55
Backflow prevention: owner or occupier required to install backflow prevention device when required to by the Corporation		42
Backflow prevention: Reporting, testing and maintenance		43
Requirement/activity	Water Services Act	
Owner must connect to sewer if sewer is completed and ready to use	98	
Owner or occupier required to repair and cleanse property sewers	92	

14 Appendix

14.1 Fire Service configurations for backflow protection

Explanation of notes to backflow boundary protection diagrams

Note 1	All backflow prevention devices internal to the property boundary or downstream of a Water Corporation service (metered or otherwise that shall be located just within a property boundary) must comply according to the following plumbing standards: AS/NZS 3500.1:2003, AS/NZS 2845.1:1998, AS 2845.2:1996 and AS 2845.3:1993.
Note 2(a)	A suitably rated backflow prevention device must be installed at the boundary based upon the maximum level of backflow risk assigned to the Customer's property.
Note 2(b)	If the water service is ≤ 25 mm in size and the customer's property is rated as a LOW form of backflow risk then Water Corporation's water service meter shall provide the necessary level of low backflow protection as the service meter has an integral dual check valve as part of its design.
Note 2(c)	If the water service is >25 mm in size and the customer's property is rated as a LOW form of backflow risk then a low rated form of backflow prevention must be installed, as a minimum, downstream of the service meter.
Note 2(d)	Where testable mechanical valve type backflow prevention devices are installed, the isolation valve upstream of the line strainer and the isolation valve immediately after the device must be resilient seated.
Note 2(e)	Where flow rate and/or pressure does not allow the use of a mechanical valve type backflow prevention device then refer to note 3.
Note 3	An Air Gap (AG) / Break Tank (BT) provides a low level form of backflow prevention protection. A Registered Air Gap (RAG) / Registered Break Tank (RBT) provides a high level form of backflow prevention protection and is commonly used as an alternative form of low / medium or high level of backflow prevention protection in scenarios where flow rate and / or pressure becomes a possible operational issue to a customer and / or DFES (Department of Fire and Emergency Services).
Note 4	Except with Water Corporation's written authority, no branch or fitting shall be connected to a private service pipe within a distance of one meter on the consumer's side of our stop-cock or water meter.
Note 5	It is the responsibility of the licensed plumbing contractor to ensure compliant plumbing work internal to the private property boundary (see Note 1). Images shown in the diagrams on page 44 are for illustrative and informative purposes only. The Water Corporation does not acknowledge nor assume any responsibility or legal liability for any non-compliant internal plumbing work as required by the Water Services Licensing (Plumbers Licensing and Plumbing standards) Regulations 2000.



14.2 Backflow boundary protection diagrams

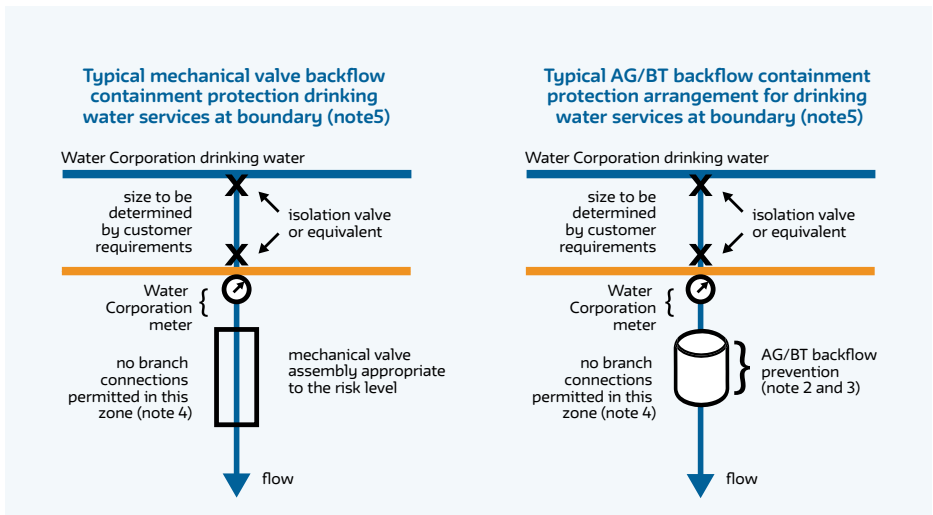
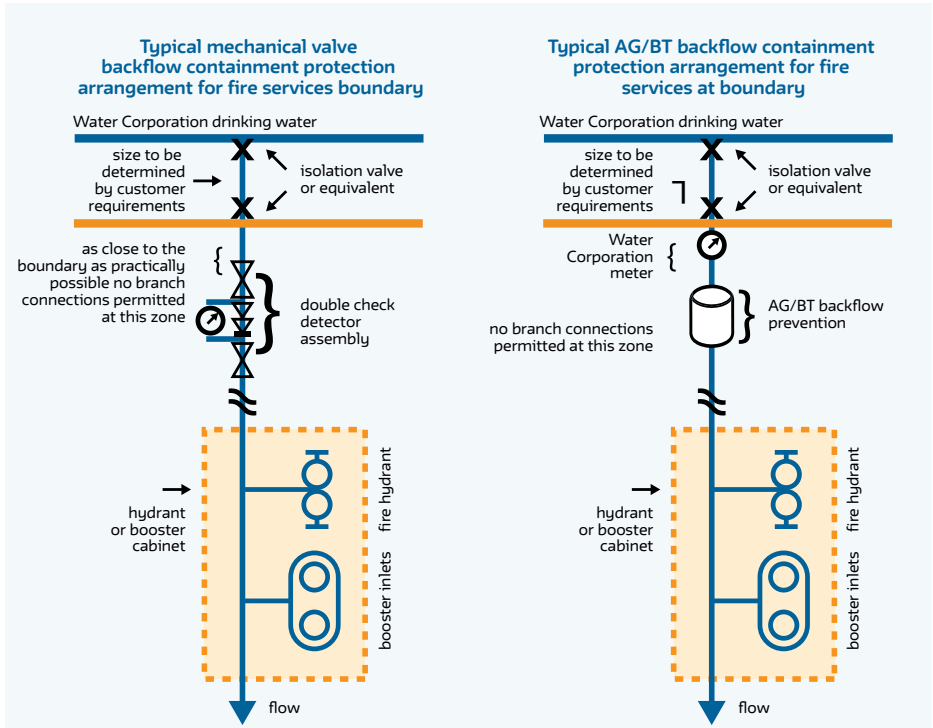



15 Contact us

BuilderNet® is the most effective and efficient way of lodging your service connection and building applications with Water Corporation.

Faults, emergencies and security

13 13 75
24 Hours

Building services and subdivision enquiries

13 13 95
8am – 5pm weekdays

BuilderNet helpline

(08) 9424 8411
8am – 5pm weekdays

Waterwise helpline

13 10 39
24 hours

Website
Email

www.watercorporation.com.au
building.services@watercorporation.com.au

