

Modular Grease Trap (MGT), Modular Grease Trap “S” Series (MGTS)

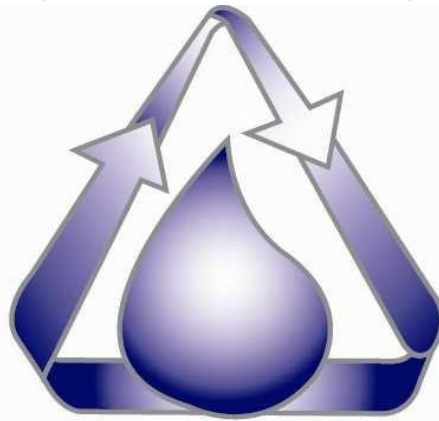

www.halgan.com.au

Installation Requirements Water Corporation

22 Ethel Ave, Brookvale NSW 2100
Postal: PO Box 255 Collaroy NSW 2097
Freecall 1800 626 753
Phone: 02 9939 8127 Fax: 02 9939 8027
Email: sales@halgan.com

For the Water Corporation Region

1.0 Design & Approvals	3
1.1 Permits and Approvals	3
1.2 Location	3
1.3 Sizing of TRAP and Grease Trap Chambers	3
2.0 Model Applicability	4
2.1 MGT	4
2.2 MGT "S" Series	4
3.1 Specification Drawing and Sizing	5
3.1 Modular Grease Trap	5
3.1.1 General Drawing (MGT)	5
3.1.2 Grease Trap Sizing (MGT)	6
3.2 MGTS Series	7
3.2.1 General Drawing (MGTS)	8
3.2.2 Grease Trap Sizing (MGTS)	9
3.3 Trade Waste Sampling Point (TWSP)	10
4.0 Detailed Design & Installation Requirements	10
4.1. General	10
4.1.1 Location	10
4.1.2 Surcharge Relief Point	10
4.1.3 Sampling Points	10
4.1.4 Piping Material	11
4.1.5 Garbage Disposal Units	11
4.1.6 Non Standard Installations	11
4.1.7 Health Requirements	11
4.1.8 Fire Resistance Level	11
4.1.9 Safety	11
4.1.10 Pumped Discharge from MGT or MGTS (Figure 1)	12
4.1.11 Pump Discharge to MGT or MGTS (Figure 2)	13
4.1.12 Typical Drainage Layout for MGT or MGTS (Figure 3)	14
4.2 Installation Requirements Modular Grease Trap - MGT	
4.2.1 General	15
4.2.2 Installation Above Ground	15
4.2.2.1 Modular Grease Trap – MGT	15
4.2.2.2 Modular Grease Trap 'S' Series	15
4.2.3 Installation Below Ground	15
4.2.3.1 Excavation dimensions	15
4.2.3.2 Over excavation	15
4.2.3.3 Installation in mine subsidence, filled, unstable water charged areas	16
4.2.3.4 Backfill/Bedding material	16
4.2.3.4.1 Modular Grease Trap – MGT	16
4.2.3.4.2 Modular Grease Trap 'S' Series	16
4.2.3.5 Final backfill	17
4.2.4 Relief Overflow Point	17
4.2.5 Protection Barricades	17
4.2.5.1 Concrete Installation	17
4.2.5.2 Installation in Bitumen & In Ground	17
4.2.6 Venting	18
4.2.7 Pipe Connection	18
4.2.7.1 Series Connection	18
4.2.7.2 Parallel Connections	19
4.2.8 Vacuum Pumpout Line	19
4.2.9 Access Lids	19
4.2.10 Installing Access Covers and Grating In-Situ concrete Method	20
4.2.10.1 Introduction	20
4.2.10.2 Preparation	20
4.2.10.3 Concrete	21
5.0 Vented Chambers	21
6.0 Warranty Card	22
7.0 Maintenance	23
7.1 Maintenance Frequency	23
7.2 Records	23
7.3 On – Site Cleaning Procedures	23
7.3.1 Modular Grease Trap (MGT)	23
7.3.2 Modular Grease Trap "S" Series (MGTS)	25

1.0 Design & Approvals

1.1 Permits and Approvals

The MGT or MGT/S hereafter both referred to as “**TRAP**” unless specified otherwise, must be installed in compliance with Water Corporation Regulations, Commercial & Industrial Services Section requirements, the WA Health Regulations and all relevant codes of practice.

Before installation of the TRAP is commenced:

1. A duly completed Trade Waste Application Form must be lodged with Water Corporation. The model and configuration of the proposed TRAP units must be stated on the form.
2. Plumbing/drainage acceptance must be obtained from the Water Corporation Commercial & Industrial Services Section. Approval of the WA Health Protection Service must be obtained if the TRAP is to be installed internally of a building.
3. It will be a condition of Water Corporation approval that the servicing and maintenance of the TRAP unit meet or exceed the requirements specified in this manual.

1.2 Location

The Halgan agent will check the location for ease of contractor access to the vacuum pump-out line. In case of doubt, the Halgan agent will request an authorised cleaning contractor to visit the site and provide written confirmation of their ability to properly service the TRAP. Water Corporation will not approve any installations which cannot be properly serviced.

1.3 Sizing of Grease Trap Chambers

Sizing recommendations - refer to table on page 6 & 9.

A correct application of the TRAP is important for maintaining an economical pump-out frequency. The following table indicates the factors, which have been found to be good indicators for determining the required model of MGT or MGTS.

Note: an economical pump-out frequency will also depend on good standards of housekeeping practice, however Water Corporation will set the final pump-out frequency.

2.0 Model Applicability

2.1 MGT

Model	MGT540	MGT1000	MGT1500	MGT2000	MGT3000
Type of Premises	as specified by Water Corporation Trade Waste for a 540 litre grease trap	as specified by Water Corporation Trade Waste for a 1,000 litre grease trap	typically for canteens, cafeterias & restaurants	typically for canteens, cafeterias & restaurants	higher capacity discharges and McDonald/ KFC stores etc
Maximum flow (litres per working day)	540 litres	1,000 litres	3,200 litres	6,400 litres	9,600 litres
Maximum seating capacity		69	199	399	500

Note: Water Corporation will determine the final size of the required grease arrester.

2.2 MGT "S" Series

Model	MGTS1000	MGTS1500	MGTS2000	MGTS3000	MGTS4000	MGTS5000
Type of Premises	as specified by Water Corporation Trade Waste for a 1,000 litre grease trap	typically for canteens, cafeterias & restaurants	typically for canteens, cafeterias & restaurants	higher capacity discharges and McDonald/ KFC stores etc	higher capacity discharges and McDonald/ KFC stores etc	higher capacity discharges and McDonald/ KFC stores etc
Maximum flow (litres per working day)	1,000 litres	3,200 litres	6,400 litres	9,600 litres	12,800 litres	16,000 Litres
Maximum seating capacity	69	199	399	500	799	1,000

Note: Water Corporation will determine the final size of the required grease arrester.

3.0 Specification Drawing and Sizing

3.1 Modular Grease Trap

3.1.1 General Drawing (MGT)

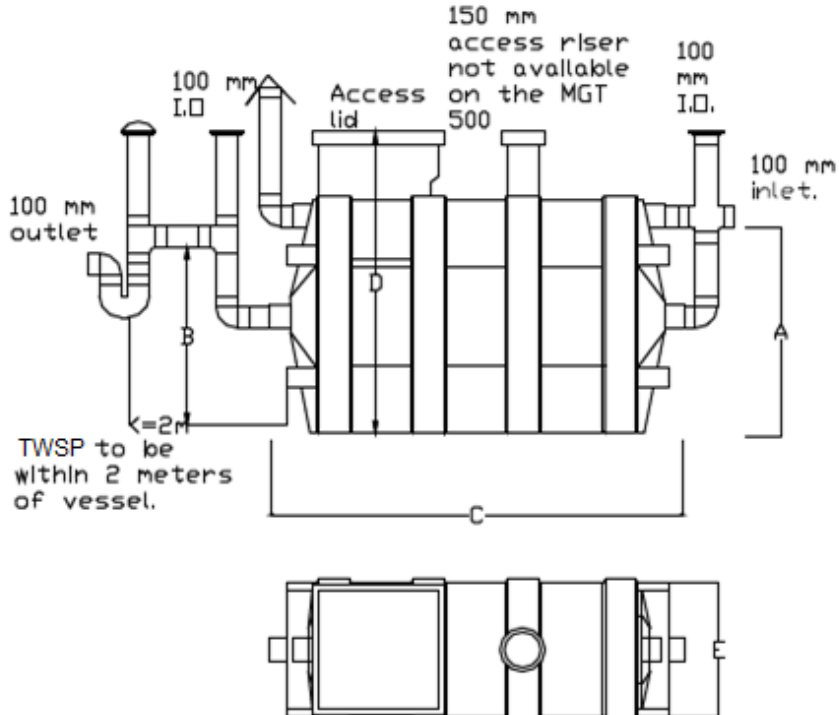

Access Lids

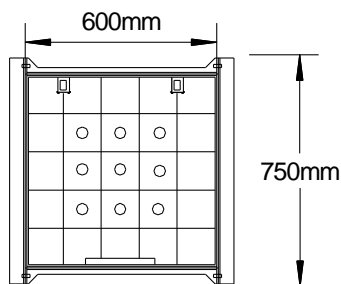

In ground access lid.
Cast iron concrete
Infill as per AS3906

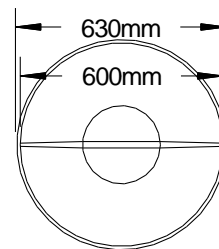

Above ground access lid.
Screw type, polypropylene.

Model	A	B	C	D	E
MGT 500	1060	980	1120	1550	720
MGT1000	1060	980	2060	1550	720
MGT1500	1060	980	3000	1550	720

3.1.2 Grease Trap Sizing (MGT)

Model	1st tank	2nd tank	Total Liquid Capacity
MGT 1000 MGT 1000.2	1000 Litres 500 litres	500 litres	1000 litres 1000 litres
MGT 1500 MGT 1500.2	1500 litres 1000 litres	500 litres	1500 litres 1500 litres
MGT 2000 MGT 2000.2	1000 litres 1500 litres	1000 litres 500 litres	2000 litres 2000 litres
MGT 3000	1500 litres	1500 litres	3000 litres

The MGT can be installed in a number of combinations. It is required to install the larger volume units first.

The total number of vessels must equal the liquid volume required, e.g. MGT 2000 can be a combination of the following:-

2 x MGT 1000's equals 2000 litres.

1 x MGT 1500, 1 x MGT 500 equals 2000 litres.

3.2 MGT “S” Series

The MGT “S” Series Grease Trap has been designed to incorporate features to not maximize performance, but to allow for enhanced servicing capabilities. The design has been refined to a cylindrical, almost “submarine” type shape, whilst maintaining the strength that is required for below ground applications. The new shape allows for solids and sludge to be captured in the purpose built servicing channel, whilst utilizing the benefits of the existing Surge Control Device design. Access has also been improved with the inclusion of two access ports, now with a circular design lid, not the traditional square access lid. The servicing channel incorporates at the lowest point a 76 mm connection for remote access. The vacuum line can be extended to street level for easy access for servicing contractors. Contact Halgan on 1800 626 753 for additional information.

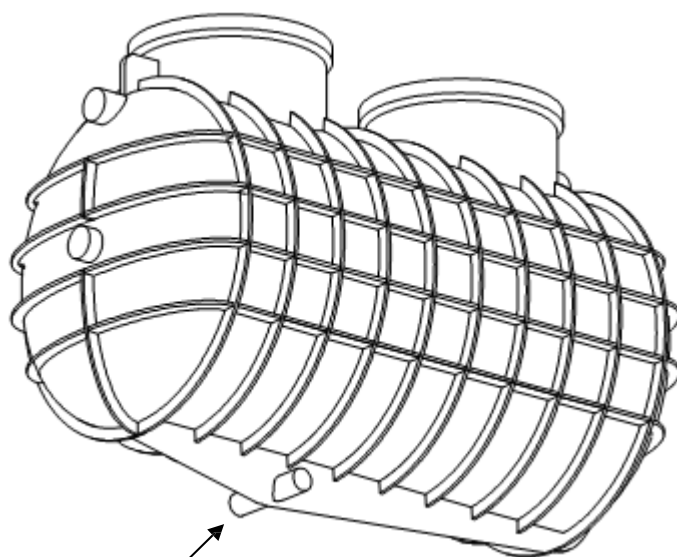

Servicing Channel
P. Patent P88084.AU

3.2.1 General Drawing (MGT "S" Series)

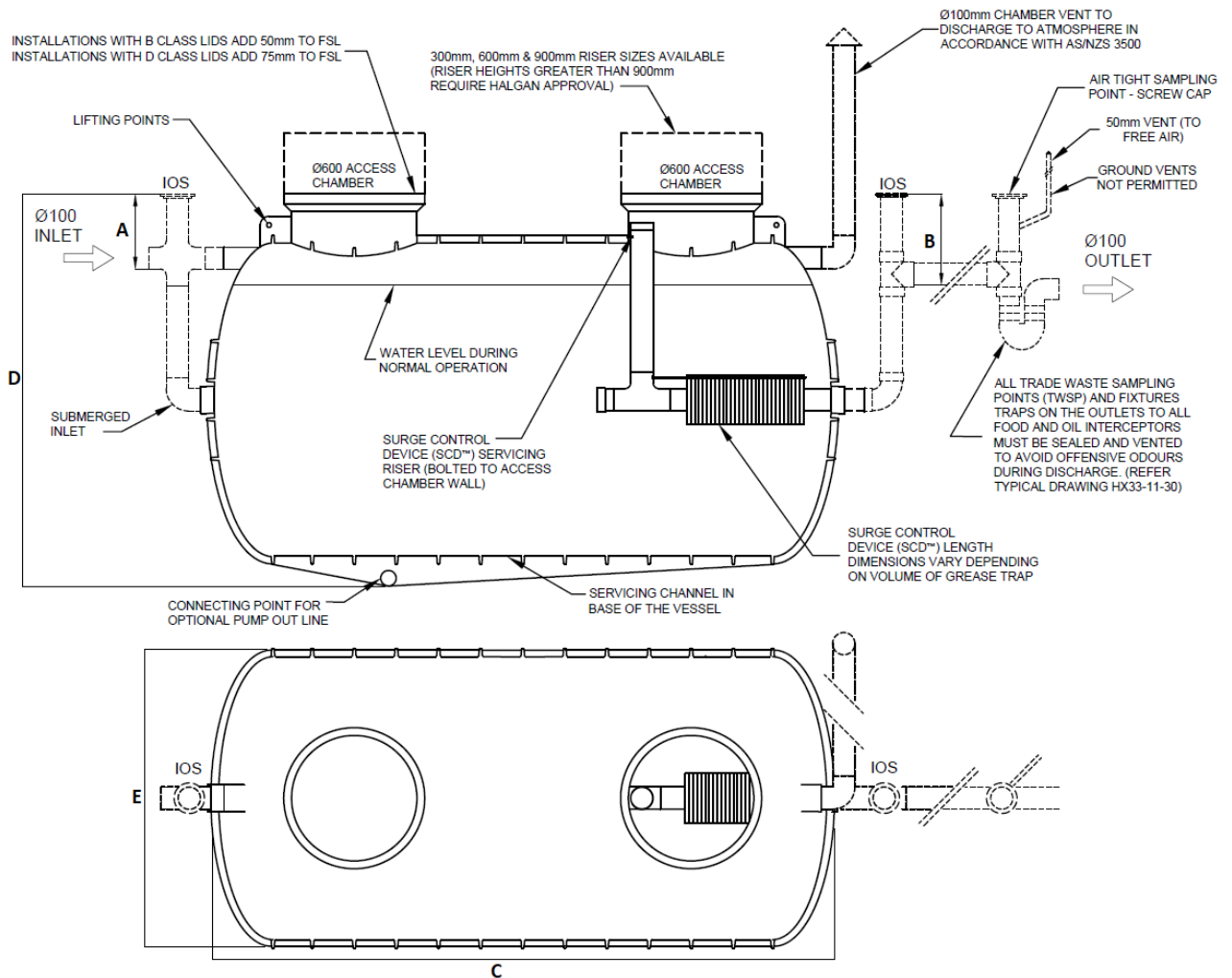

Note:

1. MGTS1000 has single access lid.
2. For Class B access lids + 50 mm Class D access lids + 75 mm
3. Measurements can vary +/- 2%.

HALGAN MGTS GREASE TRAP DIMENSIONS							
DIMENSIONS DO NOT INCLUDE PIPEWORK OR ACCESS LIDS							
MODEL	A	B	C	D	E	VOLUME	WEIGHT
MGTS1000	380mm	460mm	1700mm	1550mm	1130mm	1000 L	95 KG
MGTS1500	380mm	460mm	2280mm	1550mm	1130mm	1500 L	125 KG
MGTS2000	380mm	460mm	3010mm	1550mm	1130mm	2000 L	200 KG
MGTS3000	380mm	460mm	3055mm	1680mm	1365mm	3000 L	260 KG
MGTS4000	380mm	460mm	3250mm	1825mm	1510mm	4000 L	310 KG
MGTS5000	370mm	450mm	3200mm	1940mm	1625mm	5000 L	350 KG

3.2.2 Grease Trap Sizing (MGTS)

Model	1st tank litres	2nd tank litres	Total Liquid Capacity
MGTS 1000	1000	/	1000 litres
MGTS 1500	1500	/	1500 litres
MGTS 2000	2000	/	2000 litres
MGTS 3000	1500	1500	3000 litres
MGTS 4000	2000	2000	4000 litres

The MGTS can be installed in a number of combinations. It is required to install the larger volume units first.

The total number of vessels must equal the liquid volume required,

e.g. MGTS 3000 or MGTS 4000 can be a combination of the following:-

2 X MGTS1500 equals 3000 litres
2 x MGTS 2000 equals 4000 litres.

Model	Total Liquid Capacity
MGTS 3000	3000 litres
MGTS 4000	4000 litres
MGTS 5000	5000 litres

***Where the installation of the MGTS3000, MGTS4000, MGTS5000 units are proposed then a formal Water Corporation Trade Waste Plumbing assessment of the overall waste stream process must first be made (and approved) to determine if the MGTS3000, MGTS4000, MGTS5000 unit is the most appropriate form of Pre Treatment.**

NOTE: water Corporation will determine the final size of the required grease arrestor.

3.3 Trade Waste Sampling Point (TWSP)

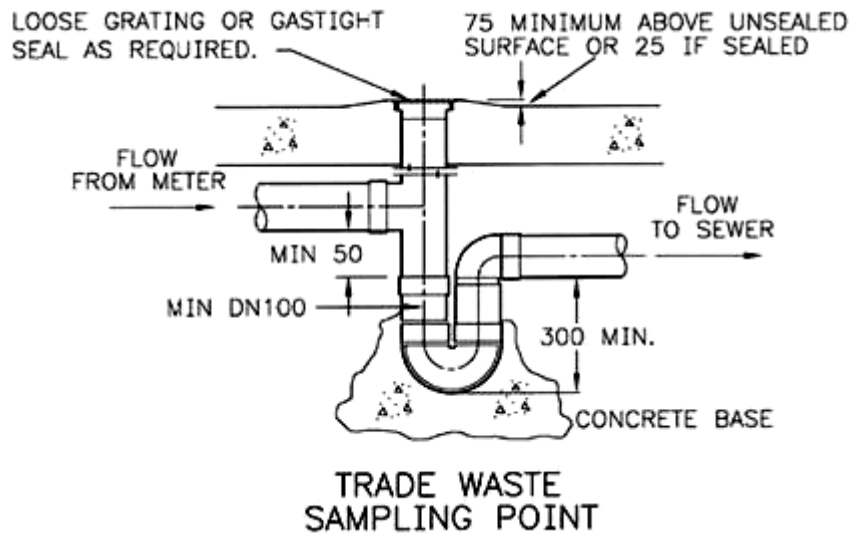

4.0 Detailed Design & Installation Requirements

4.1 General

4.1.1 Location

The TRAP is to be installed in a location that will not cause a nuisance, will not obstruct fire access, and in which it will not be damaged by vehicles or traffic or vandalised and which allows ease of access for maintenance. It is preferred to have the TRAP installed externally below ground with a gravity inlet and gravity outlet.

4.1.2 Surcharge Relief Point

The TRAP must not be used as a surcharge point. An extra surcharge gully or reflux valve may be required.

4.1.3 Sampling Points

Sampling points shall be provided at the inlet and outlet of the TRAP. If below ground, risers shall be extended to ground level and fitted with a gas tight inspection box. The sampling points can also be used for clean up points.

4.1.4 Piping Material

Copper pipe and fittings shall not be used in trade waste installation as per AS/NZS 3500.

4.1.5 Garbage Disposal Units

Garbage disposal units cannot discharge to the TRAP.

4.1.6 Non Standard Installations

Certain installations or position of installations that are unusual due to particular circumstances or matters not covered by this specification or local codes may be submitted to Halgan for consideration. Water Corporation trade waste approval for these situations will be considered on an individual basis.

4.1.7 Health Requirements

The TRAP shall be designed and installed in such a way as not to cause a danger to health arising from leakage, blockage or surcharging.

4.1.8 Fire Resistance Level

The TRAP is to be installed to maintain the Fire Resistance Level (F.R.L.) as specified in the Building Code of Australia.

4.1.9 Safety

The carrying out of work covered in this Technical Manual shall comply with the safety requirements of the relevant Authorities.

4.1.10 Pumped Discharge from MGT or MGTS

Refer to AS/NZS 3500 part 2, Pumped Discharge From Waste Fixtures for typical pumped discharge to sewer from TRAP.

Figure 1

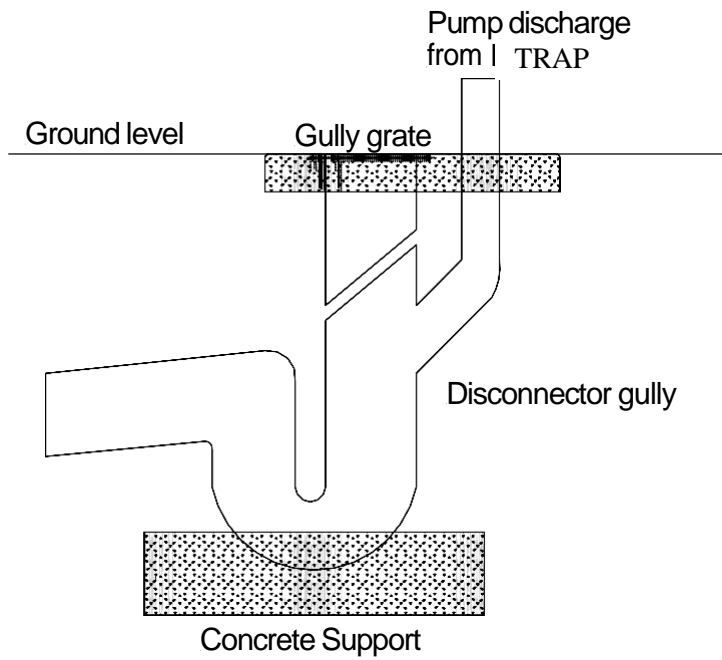

4.1.11 Pump Discharge to MGT or MGTS

The 32 mm discharge line from the ECOTEC undersink unit has to be connected to the vertical riser of the inlet line to the TRAP. Waste must enter the TRAP chamber by gravity.

Figure 2

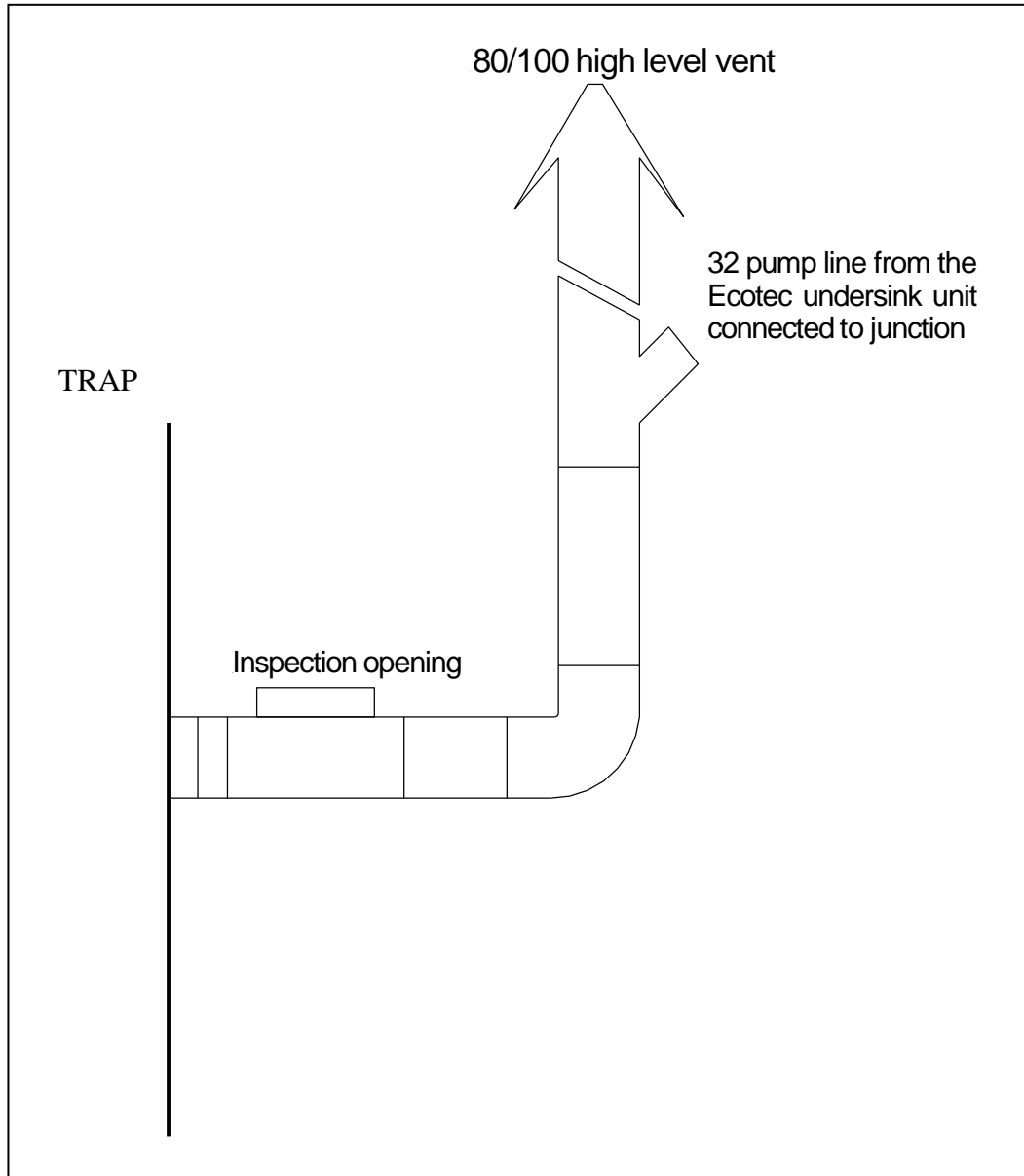

4.1.12 Typical Drainage Layout for MGT or MGTS

The TRAP must not be used as an overflow relief point. An extra overflow gully or reflux valve may be required. The drainage line upstream from the TRAP shall have an overflow relief gully as per the AS/NZS 3500. A 100 mm high/low level vent is required from the main chamber and a 100 mm high-level vent is required on the inlet line. Refer to AS/NZS 3500 Part 2.

NOTE: Refer to clause 3.1.1 page 5, clause 3.2.1 page 8, clause 3.3, page 10 for the correct installation of the Trade Waste Sampling Point (TWSP).

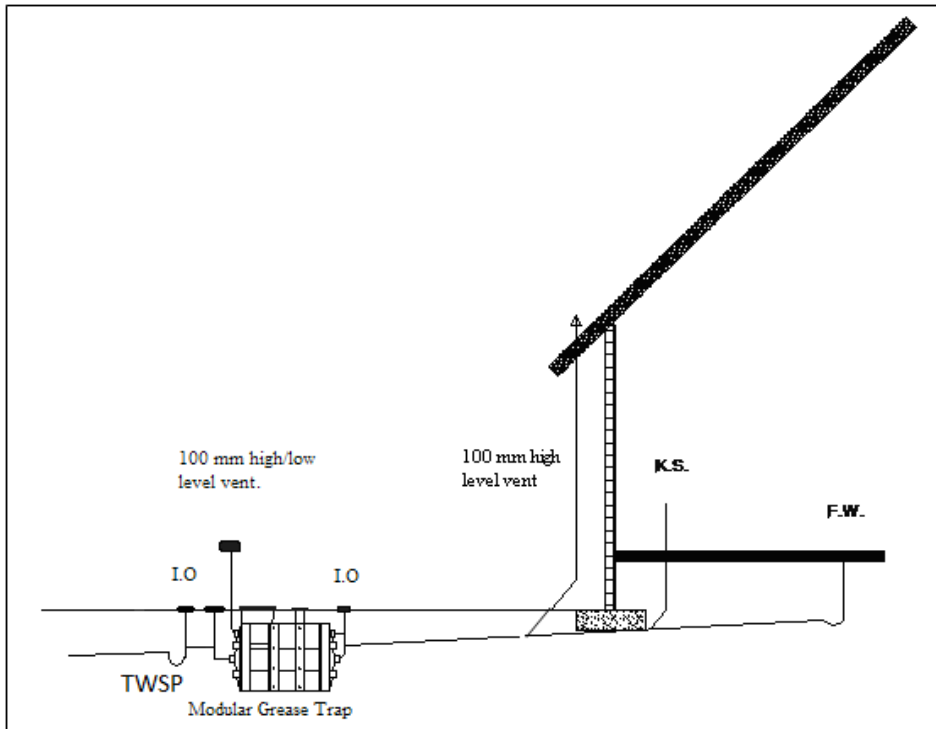

Figure 3

4.2 Installation Requirements Modular Grease Trap - MGT

4.2.1 General

The TRAP is to be installed in a location that will not cause a nuisance, obstruct fire access, cannot be vandalised or be damaged by vehicles. The TRAP must have ease of access to pumpout point for maintenance. A hose tap fitted with a Back Flow Protection Device (as per AS/NZS 3500) must be provided within 6 m of the TRAP for cleaning purposes.

4.2.2 Installation Above Ground

4.2.2.1 Installation above ground MGT

The MGT is to be supported on a 100 mm thick concrete pad or on 98% compacted level ground with 20 mm sand base. The TRAP does not require a stand. All pipes connecting to the TRAP shall be fully supported; there should be no stress on the tank connections. All storm water must be diverted away from TRAP to prevent undermining of supports or foundations.

4.2.2.2 Installation above ground MGTS Series

The MGTS **DOES** require a stand and is to be supported on a 100 mm thick concrete pad or on 98% compacted level ground with 20 mm sand base. All pipes connecting to the TRAP shall be fully supported; there should be no stress on the tank connections. All storm water must be diverted away from TRAP to prevent undermining of supports or foundations. Screw Type Polypropylene lids must be installed for all Above Ground Installations.

4.2.3 Installation below ground MGT/MGTS

All connections to the Trap shall be in accordance with the appropriate authorities. Any excavation exceeding 1.5 m in depth shall comply with the construction safety Acts and Regulations. Before backfilling, the Modular Grease Trap must be filled with water.

NOTE: In the Water Corporation area, maximum of 900 mm extension riser for the access lid can be used.

4.2.3.1 Excavation dimensions

The excavated hole width shall be kept as narrow as practicable. The depth shall be not greater than 150 mm than the required depth. A 75 mm clearance is required at the sides of tank.

4.2.3.2 Over excavation

Where an excavation has been deeper than necessary, the excess depth shall be filled either with bedding material compacted to achieve a compaction of 98% or concrete.

4.2.3.3 Installation in mine subsidence, filled, unstable or water charged areas

A qualified engineer is required to certify this application.

4.2.3.4 Backfill/Bedding

4.2.3.4.1 Backfill/Bedding material MGT

The backfill/bedding material shall be 1 part Portland cement to 5 parts clean sand. The backfill/bedding shall be thoroughly compacted by tampering at 300 mm layers. The backfill/bedding material shall encase the whole tank.

4.2.3.4.2 Backfill/Bedding material MGTS Series

The bedding material shall be granular material up 10 mm. The bedding shall be thoroughly compacted by tampering at 300 mm layers. The bedding material shall encase the whole tank.

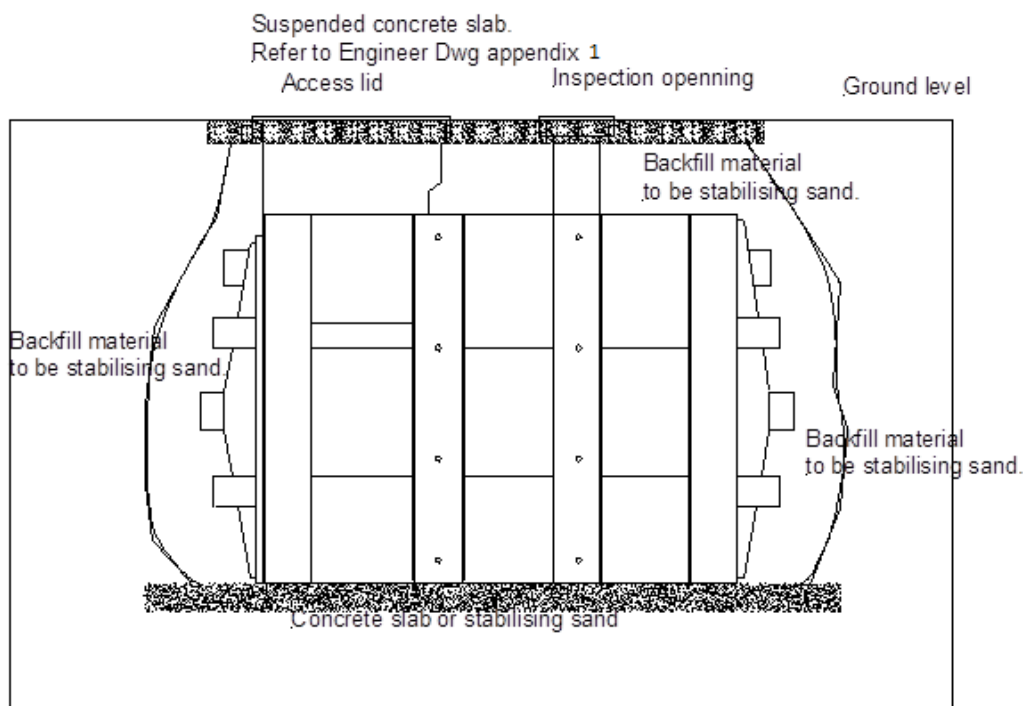

4.2.3.5 Final Backfill

The final backfill material shall comply with the following:

- (a) Spoil from the excavation of the trench may be used.
- (b) Foreign material such as builder's waste, bricks, and concrete shall not be used.
- (c) The backfill shall be compacted to restore the excavated hole as near as practicable to the normal ground.

4.2.4 Relief Overflow Point

The TRAP is not to be used as a surcharge point. An extra surcharge gully may be required or a reflux valve installed. Refer to figure in AS/NZS 3500 Part 2. The drainage line upstream from the TRAP shall have an overflow relief gully as per the AS/NZS 3500.

4.2.5 Protection Barricades

The protection barricades shall be installed to protect the TRAP from physical damage. The posts shall be manufactured from 80 mm galvanised tube (refer to material specification) with a sealing cap at the top. A 400 mm white strip shall be painted at the top of the post. The posts will be 1300 mm long and approximately 800 mm apart.

4.2.5.1 Concrete Installation

The post shall be 1300 mm long with a 200 mm x 200 mm base plate fixed to the concrete with four 12 mm x 50 mm concrete anchors.

4.2.5.2 Installation in Bitumen & In Ground

A hole shall be excavated 400 mm x 400 mm x 400 mm deep. The base shall be encased in concrete. The post will be 1700 mm long and have bituminous

paint applied to the section enclosed in concrete. The concrete shall be finished in a way that water cannot settle around the base.

4.2.6 Venting

The high level vent on the inlet line shall be 100 mm. The high level vent shall terminate above the roofline and a high/low vent from the chamber as per AS/NZS 3500. Refer to AS/NZS 3500 Part 2.

Air admittance valves are **NOT TO BE USED** in any part of the venting in the installation of the TRAP.

4.2.7 Pipe Connection

Inlet connection is a double Y junction (figure 1) or in some council areas a 90 degree slope junction (figure 2) is allowed. The top connection of the TRAP is the vent transfer to high-level vent of the inlet drainage line. The middle connection of the TRAP is the liquid connection. The outlet connection is raised and the chamber vent at the outlet side is terminated as a low or high-level vent. Check council requirements.



Figure 1

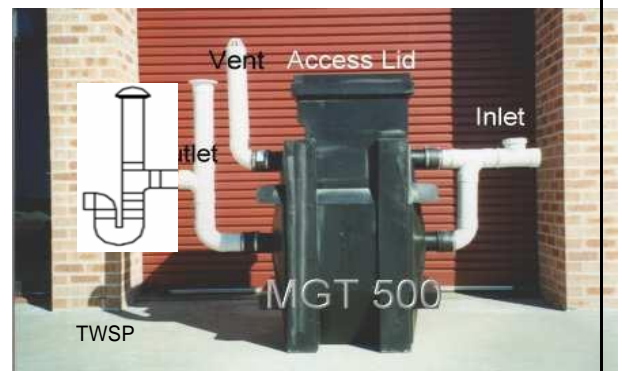
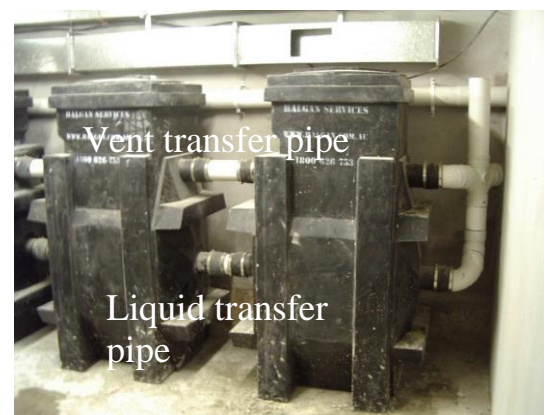

Figure 2

4.2.7.1 Series Connection

In series connections the top vent transfer pipe and the middle transfer pipe are connected to the next vessel.



4.2.7.2 Parallel Tank Positions (Connected in Series Only)

When the TRAP is installed parallel, the vent and liquid transfer pipes are connected as shown in figure 3 & 4.



Figure 3



Figure 4

4.2.8 Vacuum Pumpout Line (optional extra)

Note: Consult with pump out contractor and Customer Service Representative for correct location.

The vacuum pump out line is used by the cleaning contractor to pump out the TRAP in restricted site applications. A 50 mm M.I. quick release coupling with dust caps is supplied with the unit. The vacuum line has to be extended to the external of the building for ease of access. The lines must be as straight and short as possible. Where bends are necessary, only long radius bends should be used. The size of the vacuum line pipe can be 50 mm for the first 6 metres and 80 mm thereafter. For the "S" series Halgan can provide an **Optional Extra** 80 mm connection point. The piping and fittings material can either be class 12 pressure pipe or galvanised pipe (refer to material specification). A 600 mm long x 600 mm wide x 200 mm deep access area is required around the quick release coupling for ease of connection.

Use of vacuum pump out line must also have terminating isolation ball valves as per Water Corp GA installation guidelines. Vacuum lines not permitted to be hard plumbed. Must be installed as per WC guidelines.

4.2.9 Access Lids (refer to Engineers drawing appendix 1)

General - The top of the access lid shall be a 100 mm above ground level to stop the ingress of storm water. The polyethylene TRAP with the polypropylene lid can be installed in a non trafficable areas, eg garden beds etc. If the TRAP is in a location where it can be damaged due to gardening activities (lawn mower etc) a minimum 100 mm x 100 mm concrete edge strip is to be installed around the TRAP. **NOTE: In the Water Corporation area, maximum of 900 mm extension riser for the access lid can be used.**

Duty of Access Lids -

All covers are manufactured to Australian Standards 3996 and comply with the required design loading.

For above ground or non-pedestrian application the access lid is 600 mm in diameter and manufactured from high density polyethylene lid.

All other application the access lid shall be 600 x 600 square, cast iron, gas tight, concrete infill lid and frame. For concrete lid requirements for the Modular Grease Trap access lid and ports, refer to appendix 1.

4.2.10 Installation Access Covers and Grating In-situ concrete method

4.2.10.1 Introduction

In the IN-SITU method, the cover set is supported by the formwork or the TRAP Access Lid until the in-situ concrete is strong enough to withstand construction loads. ***The in-situ concrete must support the full width of the frame.***

Halgan covers are individually fitted to ensure a gas-tight fit. Covers and frames are not intended to be rated at not less than 28 Mpa for the supporting walls and for cover infilling.

4.2.10.2 Preparation

Ensure that the usage class is suitable for the traffic application – refer to AS3996.

Before fixing the cover into position on the formwork, clean and grease all mating surfaces of the cover set and check that the product is correctly assembled.

If the cover is bolted or rivetted to the frame, the cover may be supported directly by the formwork, otherwise, nails can be driven into the formwork so that the frame is supported at the correct level.

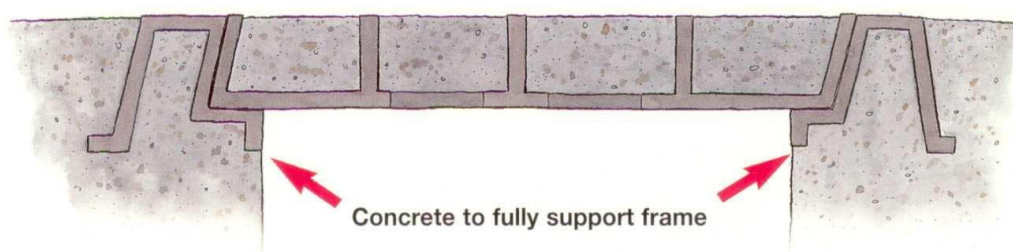

Before concreting commences, check that the cover is fully seated in the frames.

If the cover was fitted by installation bolts, these will have to be removed prior to the infilling covers. This means that infilling will have to be delayed until the concrete supporting the frame has cured.

4.2.10.3 Concreting

Place the concrete in-situ and vibrate well so that the concrete which supports the full width of the frame and fills the frame cells is well compacted and will reach the specified Mpa. Honeycombed or bony concrete under the frame will reduce the capacity of the cover and may cause it to fail at relatively low loads. If infill covers are supplied the concrete infilling is at the same time.

Screed off the excess concrete and finish the surface as required. The ribs and edges of the cover and frame should be visible.

Allow the concrete to cure before removing the cover and the formwork – premature stripping may damage the supporting concrete and distort the frame.

After the concrete has cured, remove the cover, mark the pit number on the underside of the cover (do not mix the covers) and strip the formwork.

Clean and grease all mating surfaces of the cover and frame before replacing the cover.

Where grating is being installed, references to infilling the cover should be ignored. Inadequate installation will void product warranty.

5.0 Vented Chambers

Refer to AS/NZS 3500.

6.0 Warranty Card

HALGAN PTY LTD, UNIT 2 187 South Creek Road Cromer NSW 2099

Phone: 02 9972 1355 Fax: 02 9972 1455

Modular Grease Trap warranty card to be completed and returned to Halgan Pty Ltd.

PRODUCT WARRANTY REGISTRATION CARD

NAME: _____

ADDRESS: _____

TYPE OF BUSINESS: _____

NAME OF PURCHASING AGENT: _____

AGENT ADDRESS: _____

DATE OF PURCHASE: _____

PRODUCT MODEL NO.: _____

CONDITIONS OF WARRANTY

Halgan Pty Ltd warrants that all Halgan products are free from defects. Any apparent fault will be rectify free of charge by Halgan Pty Ltd or by any of Halgan's authorised agents within appropriate time limits herein set out provided that

- * The customer produces the original invoice or other purchase document as proof of the purchase date.
- * All costs of installation, cartage, freight, travelling expenses and insurance are paid by the claimant.
- * Halgan Pty Ltd and its Authorised Dealers will not be liable for any consequential loss or damage whatsoever or howsoever arisen.
- * The Product being precision equipment has not been misused, adjusted or serviced by any person other than a service dealer, authorised by Halgan Pty Ltd.
- * The equipment has been installed correctly and is used in accordance with the Halgan Pty Ltd specifications issued with the product.
- * Nothing in these Conditions of Warranty shall be deemed to restrict any warranty required to be given under the Trade Practices Act (Commonwealth) or any consumer legislation of any State of Australia.

12 MONTH WARRANTY

* Full warranty on mechanical and electrical components. Electronic circuitry issued with a letter of acceptance from Electrical Supply Authority.

7 YEAR WARRANTY

*Full warranty on polyethylene tanks.

WARRANTY EXCLUSIONS

- * Normal user adjustments or customers instruction on the Product's operation.
- * Products purchased overseas / interstate - not designed or approved in the installed area.
- * Normal user adjustments or customer instruction on the Product's operation.
- * Abnormal product performance caused by any ancillary equipment, interference or other external factors.
- * Cleaning of the product and filters.
- * Any mileage or travelling charges outside the Service Dealer's normal service area

7.0 Maintenance

7.1 Maintenance Frequency

Any TRAP installed internally or at a location where it might cause an objection on health grounds must be on a maximum pump out frequency of eight weeks or less. In all other applications, the TRAP will be pumped out at a maximum of 3 months or when a floating layer of 75 mm grease has formed on the surface.

In all locations, Water Corporation sets the clean out schedule.

Note: The pump out frequency will depend on the house keeping within the premises.

7.2 Records

The customer shall keep, and make available, records pertaining to clean outs as specified in permit to discharge.

7.3 On-Site Cleaning Procedures

7.3.1 Modular Grease Trap (MGT)

The TRAP installation must be maintained as follows:

- Clean outs must be undertaken by approved waste collection contractor

- The contractor should make a visual observation every time they clean the TRAP to make sure it is on the correct maintenance frequency. The trade waste customer will have to be notified. Water Corporation will determine the pump out frequency.

- Remove all the TRAP access lids and access port lids, from the traps. Insert the vacuum hose into the 100 mm SCD servicing pipe in the downstream TRAP unit. Turn the vacuum pump on for 5 seconds. Insert the vacuum hose into the access port (access lid for MGTS series) of the upstream TRAP unit and remove the greasy liquid waste from the TRAP. If access is available turn the kitchen taps on to flush out the drainage line and help the cleaning process. Then insert the vacuum hose into access lid and remove any residual liquid waste. Repeat Step 3 and Step 4 in the remaining TRAP units working downstream. Then use the designated hose tap to connect the hose for cleaning of the Modular Grease Trap. At this time, hose down the SCD unit. Check the security of the SCD unit. Replace access lids and complete the appropriate servicing documents.

- If the plates from the SCD are damaged in any way then the SCD must be repaired or replaced immediately. If the connection of SCD has been broken or other plumbing connections have failed then these must be replaced immediately. The waste contractor should note on their clearance reports any damaged and failure of the SCD and plumbing pipework connecting the SCD.

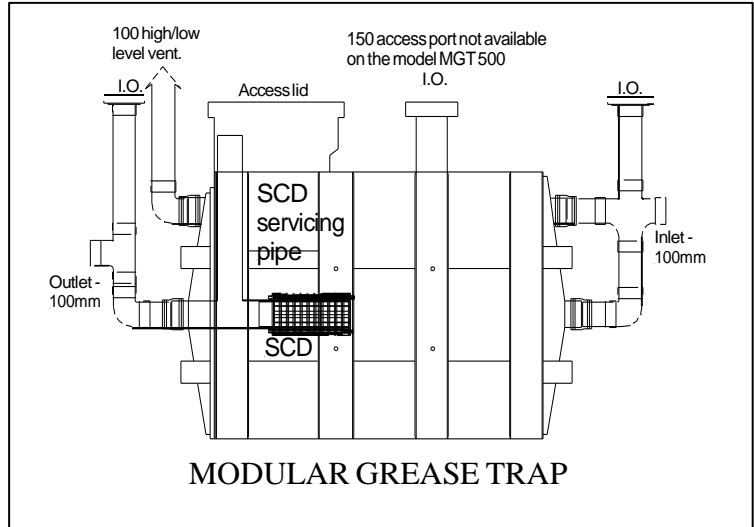

SERVICING THE MODULAR GREASE TRAP

Step One:

Remove all the MGT access lids and access port lids.

Step Two:

Insert the vacuum hose into the 100 mm SCD servicing pipe in the downstream MGT unit. Turn the vacuum pump on for 5 seconds.

Step Three:

Insert the vacuum hose into the access port of the upstream MGT unit and remove the greasy liquid waste from the MGT. Turn the kitchen taps on to flush out the drainage line and help the cleaning process.

Step Four:

Then insert the vacuum hose into access lid and remove any residual liquid waste. Repeat Step 3 and Step 4 in the remaining MGT units working downstream. Then use the designated hose tap to connect the hose for cleaning of the MGT. At this time, hose down the SCD unit.

Step Five:

Check the security of the SCD unit. If the plates from the SCD are damaged in any way then the SCD must be repaired or replaced immediately. If the connection of SCD has been broken or other plumbing connections have failed then these must be replaced immediately. The waste contractor should note on their clearance reports any damaged and failure of the SCD and plumbing pipework connecting the SCD.

Step Six:

Replace access lids and complete the appropriate servicing documents.

7.3.2 Modular Grease Trap “S” Series (MGTS)

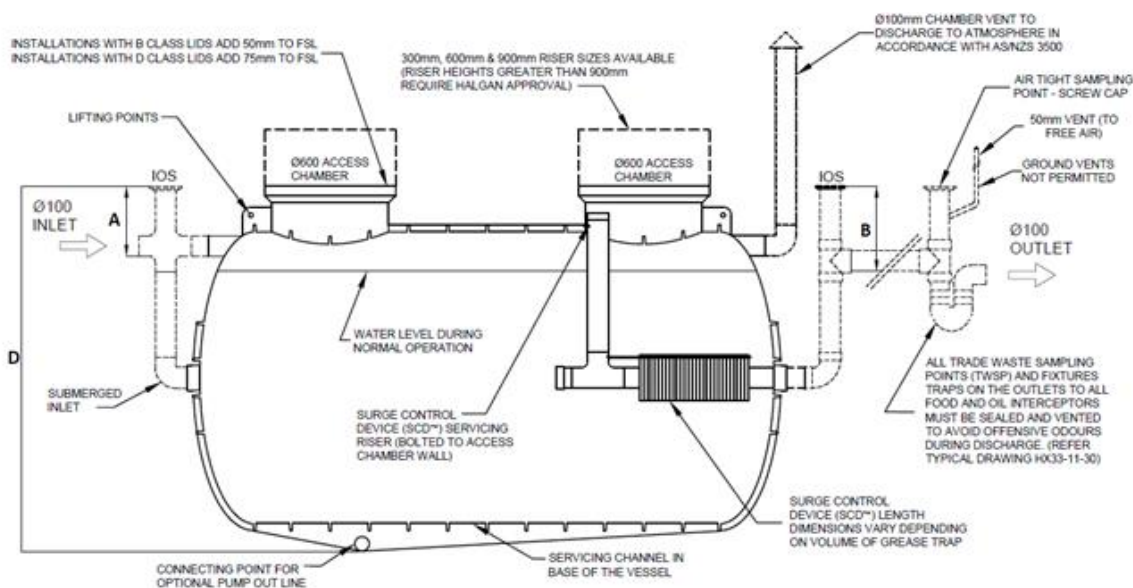

Step One:

Remove all the MGTS access lids.

Step Two:

Insert the vacuum hose into the 100 mm SCD servicing pipe in the downstream MGT unit. Turn the vacuum pump on for 5 seconds.

Step Three:

Insert the vacuum hose into the access lid for MGTS of the upstream MGTS unit and remove the greasy liquid waste from the MGTS. Turn the kitchen taps on to flush out the drainage line and help the cleaning process.

Step Four:

Then insert the vacuum hose into access lid and remove any residual liquid waste. Repeat Step 3 and Step 4 in the remaining MGTS units working downstream. Then use the designated hose tap to connect the hose for cleaning of the MGTS. At this time, hose down the SCD unit.

Step Five:

Check the security of the SCD unit. If the plates from the SCD are damaged in any way then the SCD must be repaired or replaced immediately. If the connection of SCD has been broken or other plumbing connections have failed then these must be replaced immediately. The waste contractor should not on their clearance reports any damaged and failure of the SCD and plumbing pipework connecting the SCD.

Step Six:

Replace access lids and complete the appropriate servicing documents.

Appendix 1. Engineers Access Lid Drawing

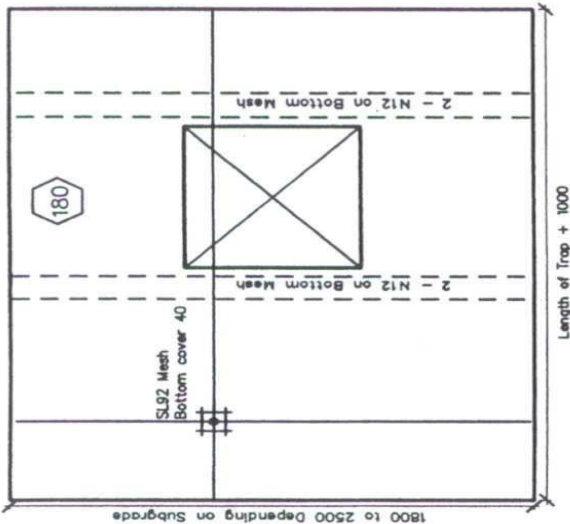

NOTE:
New slab to be dowelled into existing slab with N12 dowells 300 long at 600 centres.

GREASE TRAP LID FOR HALGAN PTY LTD

Scale 1:20

CONCRETE NOTES:

- All concrete work to be in accordance with AS 3600.
- $f_c = 32$ MPa for All external slabs & columns.
- Maximum aggregate size = 20 for footings, slabs & beams.
= 10 for block filling.
- Slump = 80.
- All concrete, including block filling, to be vibrated.
- Slabs to be kept damp for at least 14 days after placing or to be protected by an approved curing membrane.
- Bar Chairs to be no more than 80mm c/c to c/c spacing.
- Reinforcing Steel to comply with AS/NZS 4671:2001, and to be D500M unless noted otherwise. (where 500 = strength grade in megapascals & N = Normal ductility class)
- Reinforcement to be tied at every other intersection minimum.
- Welded roofing being used as formwork (not Bonddeck or similar).
Depth of Slab must be taken from the top of the Roof Rib.
Specified bottom cover must be taken from the top of the Roofing Rib.

IMPORTANCE OF CURING CONCRETE

COMPRESSIVE STRENGTH AT 28 DAYS AS A % OF CONTINUOUSLY MOST CURED SAMPLE

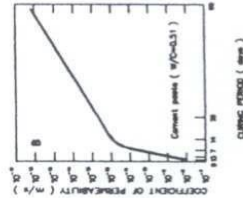
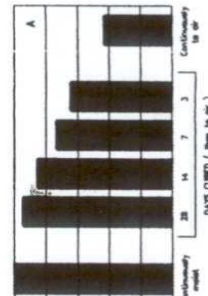

Effect of curing duration on : (A) compressive strength; and (B) concrete permeability
Acknowledgement : Diagram is based on fig. 1.2 of Guide to Concrete Repair & Protection (SAA/1986:1996)

PLAN OR DOCUMENT CERTIFICATION

I am a qualified...CIVIL, GEOTECHNICAL & STRUCTURAL ENGINEER...
I hold the following qualifications or licence No.....M.Eng.Sc.....
.....F.I.E.Aust.....Nper3.....Struct.Civil.No.149788.....
Further I am appropriately qualified to certify this component of the project.
I hereby state that these plans or details comply with the conditions of development consent, the provisions of the Building Code of Australia, A.S.1170., A.S.1170.1, A.S.1170.2, A.S.1684., A.S.3600., A.S.3700., A.S.4100

Jack D. Hodgson *[Signature]*
Name Date
Signature

No. Amendment Drawn Date

**GREASE TRAP LID
PROPOSED ADDITION**

HALGAN PTY LTD

The Structural Details shown on this Drawing are Not to change under any circumstance. No Certificate will be issued for work Not in accordance with this Drawing.

JACK HODGSON CONSULTANTS PTY. LIMITED.
Consulting Civil, Geotechnical, and Structural Engineers.
11 Bungen Street, MONA VALE P.O. Box 389, Post Code 2103.
Telephone (02) 9979 6733. Facsimile (02) 9979 6926. A.C.N. 053 409 011

Designed JDH Drawn ARC Job No. Drawing No.

Checked JDH Scale 1: 100,20, uno.

Date 22 FEBRUARY 2002

19612-1