

Grease Guardian®

X Range

Automatic Grease Removal Unit

INSTALLATION
OPERATION MAINTENANCE

MODELS GGX7, 15, 20, 25, 35



MANUFACTURED BY FM ENVIRONMENTAL

www.greaseguardian.com



CONTENTS

Grease Guardian X Range	2	APPENDICES	
How it Works	3	Wiring Diagram	26
Dimensions & Specifications	4-5	Warranty	28
Installation	6-9		
Grease Guardian Controller	10-17		
User Maintenance.....	18-19		
Tri-Monthly Servicing.....	20		
Troubleshooting	21-23		
Components Overview	24-25		

GREASE GUARDIAN X RANGE

The FM Environmental Grease Guardian X series automatic grease removal unit (GRU) is a totally engineered system for separating free floating grease and oils from drain water flows. The separated grease and oils are trapped within the stainless steel tank and are automatically recovered by the system. Only the "cleaned" water is allowed to pass through the system into the drain lines. Each unit also separates solid food waste into a removable basket. The Grease Guardian can be used in a wide variety of applications from restaurants and food processing operations to many types of industrial operations.

Use of the Grease Guardian assures that costly sewer surcharges and fines are minimised or eliminated through efficient separation and removal of the grease and oil. In addition, rapidly escalating pumping and disposal costs, which are associated with conventional grease traps or interceptors are also reduced or eliminated. When properly operated, the recovered grease and oils are virtually water free so they can be collected by a local rendering Company or recycler.

HOW IT WORKS

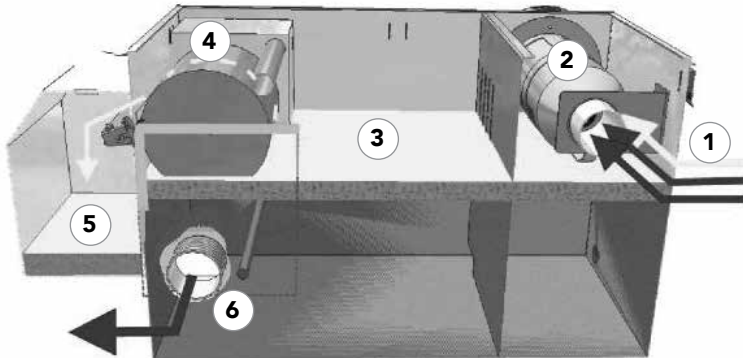

Rear view section

- 1 Grease, solids and wastewater from the kitchen enters the Grease Guardian.
- 2 Solid food waste is caught in a removable cylindrical strainer for easy disposal.
- 3 One of the programmed cycles is set. The grease passes into the middle chamber through slots in the baffle wall where it remains trapped. With the assistance of a heater the grease separates from the wastewater and rises to the surface more rapidly.
- 4 The liquefied grease adheres to the rotating skimming drum
- 5 The grease passes down a scraper blade into a collection container where it can be removed and disposed hygienically.
- 6 The treated water exits under a baffle wall and through the outlet to drain.

PRODUCT DIMENSIONS & SPECIFICATIONS (110V)

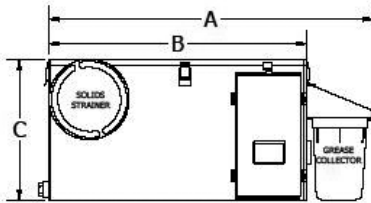

Front view

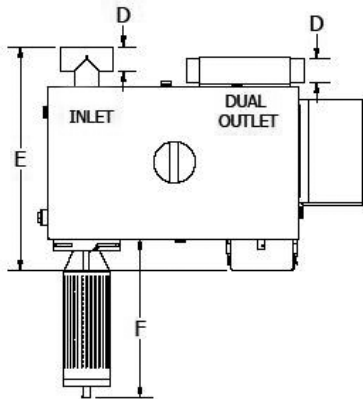

Top view



Side view outlet end

Model	<i>(inches)</i>							
	A	B	C	D*	E	F	G	H
GGX7	27	20½	13¾	2	20¾	15¾	9½	7
GGX15	31½	24½	13¾	2	22	15¾	9¾	4½
GGX20	32½	26¼	15	2	22	15¾	11½	6¼
GGX25	32½	25¾	16½	2	22	15¾	12¾	7½
GGX35	40¾	34½	16½	3	24	15¾	12¾	9

* Inlet/Outlet nominal pipe size (NPS)

Model					
	GGX7	GGX15	GGX20	GGX25	GGX35
Hydraulic Flow gal/min	7.00	15.00	20.00	25.00	35.00
Strainer Basket Cap, gal	1.45	1.45	1.45	1.45	1.45
Grease Collector Cap, gal	1.18	1.18	1.18	1.18	1.18

Casing Material 16 Gauge; 304 Stainless Steel; (all models) Bright finish

Motor 25 Watt 110v, 60 Hz (all models) 4.5 µF capacitor

Heater 600 Watt, cartridge, 110v, (all models) Thermal cut-out inc.

Time Control Logic Controller: (all models) Backlit display
Inputs 110 VAC
Outputs 110 VAC
Battery back up

Skimming Maximum skimming rate in (all models) test conditions 1.32 gal/hr

PRODUCT DIMENSIONS & SPECIFICATIONS (240V)

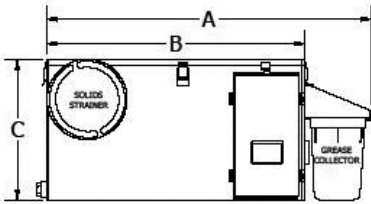

Front view

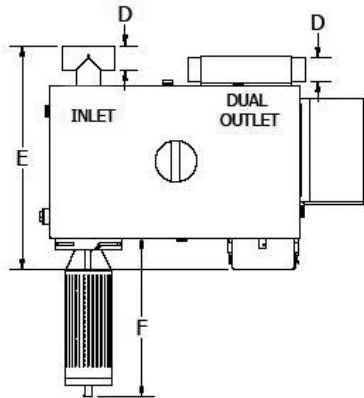

Top view

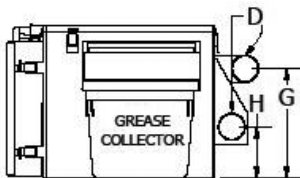

Side view outlet end

Model (mm)

	A	B	C	D*	E	F	G	H
GGX7	686	453	340	40	520	401	240	185
GGX15	788	623	341	50	560	401	214	125
GGX20	826	660	381	50	560	401	288	160
GGX25	826	660	421	50	560	401	288	160
GGX35	1039	876	421	80	610	401	288	187

* Inlet/Outlet DN pipe size

Model

	GGX7	GGX15	GGX20	GGX25	GGX35
Hydraulic Flow l/sec	0.50	0.94	1.25	1.58	2.21
Strainer Basket Cap, Litres	3.00	3.00	3.00	3.00	3.00
Grease Collector Cap, Litres	4.50	4.50	4.50	4.50	4.50

Casing Material 16 Gauge; 304 Stainless Steel; (all models) Bright finish

Motor 25 Watt 240V, 50 Hz (all models) 1.3 µF capacitor

Heater (all models) GGX7 & GGX15/20 - 600 Watt, cartridge, 240V, Thermal cut-out inc.
GGX 25 & GGX 35 - 1000 Watt, cartridge, 240V, Thermal cut-out inc.

Time Control (all models) Logic Controller: Backlit display
Inputs 240V AC
Outputs 240V AC
Battery back up

Skimming (all models) Maximum skimming rate in test conditions 5 litres/hr

INSTALLATION

Part I: Grease Guardian X Rear View – Straight Through Example

To plan a suitable location for the GGX first refer to “Product Dimensions and Specifications” page in this manual to check available clearances. Position the unit as close as possible to the fixture it is serving to minimize grease build-up in the piping.

Do not connect the system to food grinders, potato peelers or waste disposal units. Such installations will void the Grease Guardian's Warranty.

Connection Sequence:

- 1 Inlet piping. - Drain piping from the sinks/oven should be 2 inch Ø (50mm) minimum. Ensure that a fall of $\frac{1}{3}$ " inches per foot (1:40) is used and keep the inlet pipe as short as possible to avoid grease build-up before it reaches the unit. If the unit is serving more than one fixture ensure that the respective drain pipes are joined in a T-piece before they enter the unit piping. Install "P" or "U" trap in the inlet piping from sinks as normal. Rubber Couplings with screw clasp are included.
- 2 Outlet piping - Ensure a fall of $\frac{1}{3}$ " per foot (1:40), only use "sweep" connections and minimize the number of bends used. Do not reduce the size of the pipe used in the outlet, keep the outlet piping as short as possible and do not install any P-traps (the units has an in-built internal gas trap). Note that if the unit overflows during operation the problem normally lies with the size and layout of the outlet piping which is not fit to take the full flow freely.

3 Applies only for installations in the US:

The unit is provided with an internal flow controller to limit the flow going through. If the local plumbing code requires a vertical type flow regulator, or if the unit is receiving flow from fixtures installed at head (over 6 ft, such as when installing units in basements) and to comply with PDI requirements, a proper flow control device with air intake must be fitted on the inlet piping. Suitable air intake pipework should be

routed to the top of this flow controller and connected to a vented waste stack within the building. Note that if the Grease Guardian is serving multiple fixtures, some plumbing codes ask that each fixture is equipped with its own flow control device.

Plumbing Drainage Institute Flow Control with Air Intake

GGX7 units, part reference: 22107

GGX15 units, part reference: 22115

GGX20 units, part reference: 22120

GGX25 units, part reference: 22125

GGX35 units, part reference: 33135

- ④ Inlet and Outlet piping connections. Rubber Couplings with screw clasps are included.
- ⑤ Rubber blanking caps - included, for sealing off disused inlet/outlet ports.
- ⑥ Single Phase Three Pin Plug – connect to water proof socket. To provide continued protection against risk of electric shock, connect to properly grounded outlets only.
- ⑦ To avoid possible siphoning problems, an outlet pipe vent (or code approved air admittance valve) which is at least $\frac{1}{2}$ the outlet pipe diameter should be located as close as possible to the Grease Guardian unit.
- ⑧ Upon request Grease Guardian X unit comes complete with a wash spray bar located inside the main chamber. With all grease removal units, and depending on the application, over time a crust may form on the surface that inhibits proper operation and grease recovery. In such applications the frequent use of the washing operation ensures best treatment. A hot water supply is to be plumbed to the $\frac{1}{2}$ " inlet connection to allow the spray wash operation if required.

All instructions and drawings provided in the booklet are for reference only. The equipment provided is to be installed in compliance with local legislation, regulation and codes. Installation by a qualified plumber who is knowledgeable on the local plumbing codes is necessary.

Part I: Further Plumbing Arrangements

Refer to specification page in this manual for minimal clearances before finalizing unit location and orientation

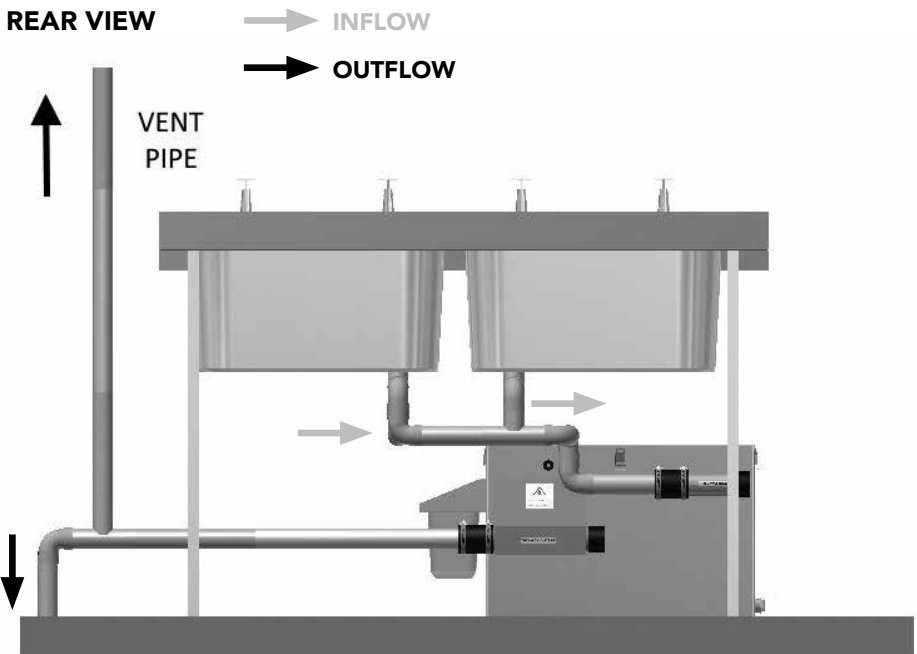
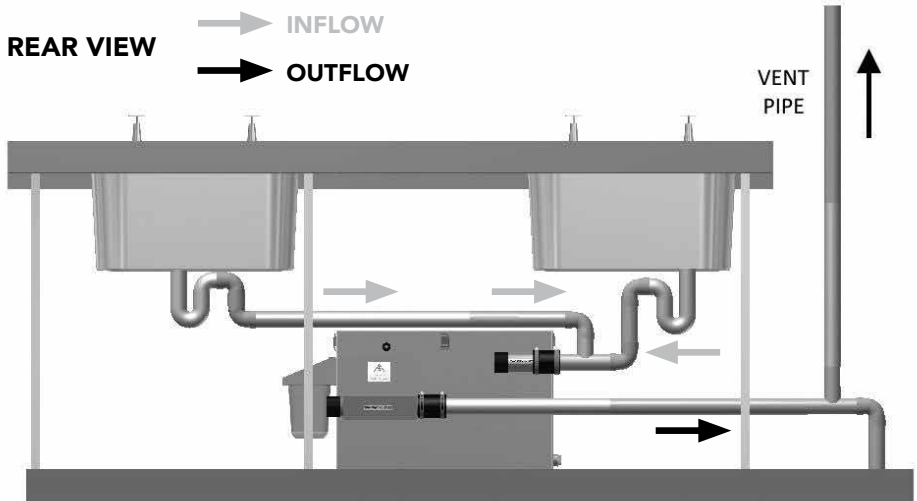

Part II: Pre start up checks

1. Ensure the unit is positioned on a level surface only and is plumbed in securely.
2. The Grease Guardian unit should only be plugged into a properly grounded 3-prong 115 VAC 1 phase or 230 VAC 1 phase outlet. Ensure electrical outlet is waterproof and is fitted with or supported by a dedicated ground fault circuit breaker/interrupter (GFCI).

Points 3 and 4 below should normally be carried out by your market representative as part of a formal unit commissioning:

3. Prior to mains switch-on ensure the unit is filled with water to the correct settlement level which occurs when the inflowing water stabilises at the base of the skimming drum. Ensure strainer basket is in the fully closed position.
4. Set the controller time of day and appropriate cycle programme in accordance with timer setting instructions detailed in this manual.

HEALTH, SAFETY AND EFFICIENCY

- **NEVER TURN UNIT ON** before filling with water as instructed above
- Disconnect unit from mains before accessing any electrical components
- The unit requires daily housekeeping. Quarterly service by an approved engineer is recommended
- The unit will lose efficiency if not maintained properly
- The unit is designed to trap and remove free floating grease oils and fats only
- To help ensure the highest efficiency reduce solid foodwaste by installing primary strainers or scraping waste into bins before washing. The "secondary" solids basket provided protects the unit from solid food waste build up
- Consult your supplier in the event of increased loadings to the Grease Guardian
- Do not use Hazardous detergents
- to clean the unit, and do not pour detergents directly in to the unit.
- Do not install unit externally unless weather proof cover is used
- Do not install the unit in any manner except as tested and rated under ASME A112.14.3 and ASME A112.14.4
- Do not connect food grinders, potato peelers, waste disposal units or similar devices upstream from the Grease Guardian
- Ensure the unit is level and installed flat on the ground or frame where specified
- Remove blockages and grease build up from drains before installing the Grease Guardian
- If the supply cord is damaged it must be relaced by the manufacturer or authorised distributor
- Operation of the unit must be performed by trained personnel only

CONTROLLER

Time of Day and & week day setting

- only to be set during commissioning

Time of the day

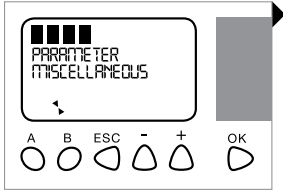

From the main display access the above display by pressing OK and ESC together. Choose "Miscellaneous" using - or + keys then press OK.

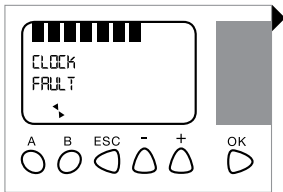

In the follow on display use the + and - keys to move the flashing bar to select "CLOCK". Press OK to confirm.

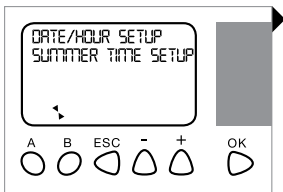

Next, use the + and - keys to select "DATE/HOUR SETUP", and press OK.

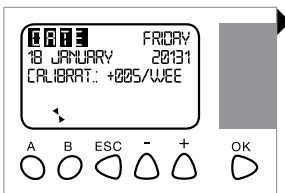

Use the + and - keys to move the flashing bar to select current hour and minutes blocks. Enter and change these digits by pressing OK, then use + and - keys to increase/decrease values. Press OK to confirm current value. Press ESC to save and return to home display.

Week Day Setting

Note: The controller is factory set with all 7 days set to active.

Only reprogram if this is not suitable and there is a requirement that the unit does not need to operate on particular days during the week.

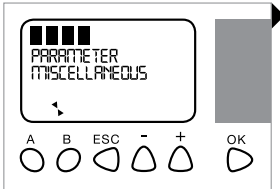

From the main display access the above display by pressing OK and ESC together. Choose "Parameter" using - or + keys then press OK.

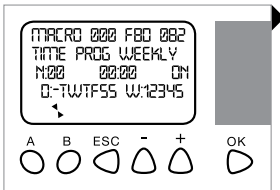

The above display will show. Next using only the "-" key move the cursor to the "D:MTWTFSS" block (days of week). To access particular day value press OK. Then press "-" to cancel any day. Pressing OK confirms cancellation and moves the cursor to the next day. On reaching final day value, S, press OK to confirm all.

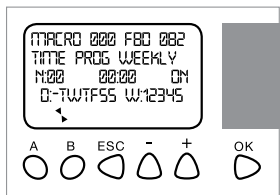

Example:
Controller set to OFF at weekends; the display is configured as above. Press ESC to exit to home display.

GREASE GUARDIAN CONTROLLER

Cycle Programming

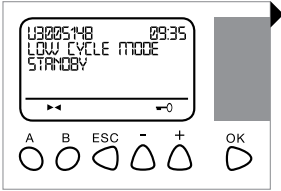

Main display

Initial Note: if no user adjustments are made a factory setting from 8am-12pm starts the unit on a LOW cycle daily. This is adequate for smaller applications including out of town delis, or small restaurants. Refer to appendix 1 at back of this manual for recommended settings for your application.

After machine switch-on, the home screen appears displaying the controller software version (in this case U for USA and version date ddmmy). The current time of day, and cycle mode are also displayed. The unit displays "Standby" when not in cycle.

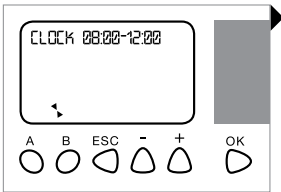

To change a cycle first choose from one or more of the 4 hour programs 08:00-12:00, 12:00-16:00, 16:00-20:00, and 20:00-00:00, accessed by pressing the **OK** and **A** buttons together. Then advance through the time slots available by re-pressing **A**.

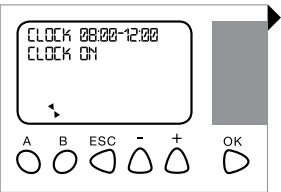

Any time-slot can be set to ON/OFF by pressing the **B** button. On completion press **ESC** to return to the home Screen.

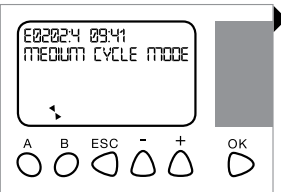

Finally in the home screen press and hold either the + or - keys for 1 second to fine tune the cycle duration. The display will indicate the adjustment made from 3 options:

- **LOW Cycle Mode**
- **MEDIUM Cycle Mode**
- **HIGH Cycle Mode**

The time control displays the following information at various stages of a cycle.

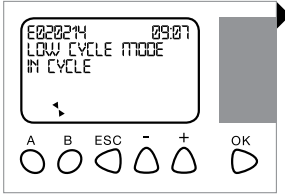

During a cycle the heating element and skimmer motor are activated intermittently to heat up and skim fats oils and greases. The main display flashes the message **IN CYCLE**. The full cycle sequence is shown in Appendix 2 for program options available.

Additional features

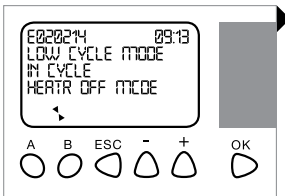

Heater Off Mode

When wastewater entering the unit is sufficiently hot or if light oils are being intercepted the heater element may not be required. With this in mind there is an option to run cycles with the heating element deactivated. This feature will also provide savings on energy bills.

To disengage heating element: from the Home Screen hold in button “**B**” for 10 or more seconds. The display appears as shown. In this mode the system runs any cycle with only the skimmer motor running at its normal pre-set operation. This cycle sequence is also shown at the bottom of Appendix 2.

To re-engage the heater simply hold in the **B** button again for 10 seconds until The “HEATER OFF MODE” is cleared.

Building Management System Feature:

Please note that the output switch No. 4 of this controller is available for connection to BMS system. The rating for this output is 24 to 250VAC, 8 AMPS max.

The signal to BMS from this output is factory programmed to indicate power ON during normal operation of the controller.

If either a/ there is a power failure or b/ if the main tank lid is misplaced from the system for more than 10 minutes, then the continuous signal to BMS is interrupted, indicating that either of these faults has occurred.

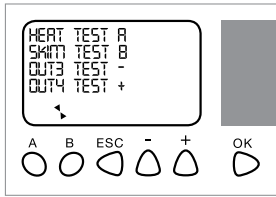

Test Mode

A test of electrical components can be carried out. Press - and + together to access this screen from the Home display. Next press any of the Test mode keys to activate the corresponding output:

- Press **A** key to activate Heater.
- Press **B** key to activate motor/skimmer.
- Press - key to activate Output 3.
- Press + key to activate Output 4.

Return to main menu by pressing **ESC**.

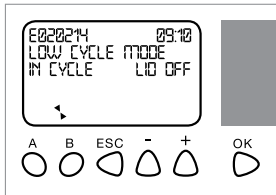

Lid Off Alert

If the main tank cover is removed from the unit at any time both the heater and motor will be stopped automatically for safety reasons. The display will flash a **LID OFF** alert until the lid is replaced. Power is restored to the heater and motor after the lid is replaced.

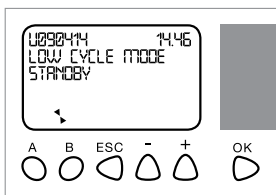

Daily Maintenance Access Time; Standby Mode

1 or 2 times daily both the solids strainer and plastic grease collection container should be checked and emptied. It is preferable that these tasks are only carried out when the unit is NOT in cycle and is in **Standby** as shown on the display.

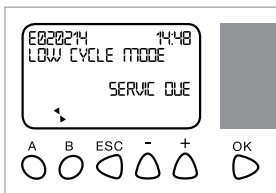

Scheduled Service Reminder

The Grease Guardian unit requires periodic service inspection and pump out by qualified personnel. To assist, the controller is pre-set to display a service due reminder as shown on the due date. Please contact your Service Provider when this display appears. The reminder will normally flash at least once every 90 days in line with service and pump out requirements for this product.

Additional Program Screen For Solenoid Equipped Units, Including GGX7 Standard

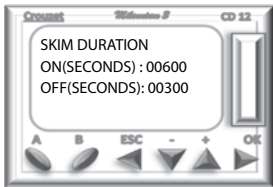

SKIMMER DURATION SCREEN

The default for the X7 unit is 600 seconds ON and 300 seconds OFF. To adjust: use keys "-" & "+" to navigate to the ON value. Then press "OK" to lock on to the value. Next use "-" & "+" again to increase or decrease the value. Confirm the setting by pressing "OK" again. Next move the cursor using "-" & "+" to the OFF value and repeat the setting procedure, confirming settings with "OK".

ADDITIONAL SCREEN:

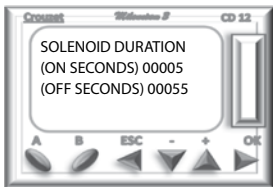

SOLENOID WASH SETTING SCREEN

In GGX7 units and any X15-35 unit with a solenoid upgrade, pressing "A" again after the Skimmer Duration screen settings are complete will call up the solenoid duration display. This display sets time limits for water flowing to the spray bar. The default on this unit is 5 ON and 55 OFF. To adjust: use keys "-" & "+" to navigate to the ON value. Then press "OK" to lock on to the value. Next use "-" & "+" again to increase or decrease the value. Confirm the setting by pressing "OK" again. Next move the cursor using "-" & "+" to the OFF value and repeat the setting procedure, confirming settings with "OK". After all settings are made, Return to Home Screen by pressing ESC.

USER MAINTENANCE

Part I: Daily Strainer Maintenance, 1-2 times daily

Attention: Ensure sinks are fully emptied before accessing the strainer basket! While the strainer basket is out of position for cleaning, no water should be drained from the sinks or fixtures.

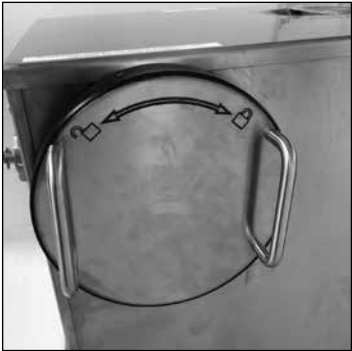

Strainer cap shown in the locked or closed position.



To unlock the cap rotate it counter clockwise using the hand grips.



Shake off excess water before removing strainer by turning it while still in its internal cage mount.



Next remove the strainer by simply sliding it forward.

After cleanout replace the strainer inside the tank and replace the screw cap back into its locked position.

Part II: Daily Grease Collection Maintenance, 1-2 times daily (depending on amount of oil collected)



When the grease container is about 3/4 full remove it by sliding it outwards as shown. Dispose contents to an on site oil recycling bin or bulk oil waste container.

Part III: Additional Maintenance — Wiper Blade Weekly Check



Check and clean the wiper blade. Access is gained to the blade by removing the grease container and hood from its hanging bracket as shown.

After cleaning, reposition the wiper blade.

Once in position replace the main lid, container hood and grease container.

TRI-MONTHLY (90 DAYS) SERVICE

By approved Service Partner

To ensure correct longterm performance and to comply with our warranty terms all units **must** be serviced tri-monthly. This must be carried out by an FM Environmental approved service partner in possession of the necessary waste carriers licence for your area.

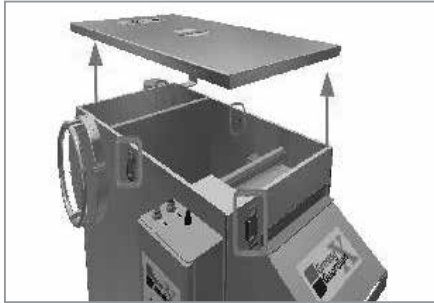

1. The mains supply to the unit must be first switched off!. The main Lid is removed by unclasping the fasteners highlighted in diagram.



2. The internal chamber walls are power/steam cleaned. Both chambers are then pumped out completely. The heating element should be checked and cleaned using a plastic brush. The unit is refilled using the water flow from the sink.



3. Inspection of wear and tear parts. Including wiper blade, lid seal gasket and strainer seals. Replacement of any parts found to be worn or defective.



4. Electrical checks including controller, heater and motor checks. Optimisation of operation should be made if necessary.

TROUBLESHOOTING

PROBLEM: Unit not removing grease

Is the power on?

Check that the power is on and that the time control is set correctly. If the power is being supplied and there is no display check fuses or contact your supplier.

Is wiper blade and wiper slot clean?

Clean any build-up present on the wiper blade assembly and the grease exit slot. Ensure the wiper blade is located in place and it makes proper contact with skimming drum. Remove the main lid to check this if necessary. Replace wiper blade plastic end if worn.

Check the cycle status

First check that "IN CYCLE" is displayed at the start of a cycle. Later in the cycle the skimming motor should be audible. Should there be no skimmed grease emerging during the cycle a further test can be conducted by entering TEST mode as described earlier in this manual. With the main lid removed and **with hands kept clear of the skimming drum** use this feature to check that the motor is running by pressing the B button when in the TEST mode.

Inadequate Heating?

With the lid removed press the B button when in TEST mode. If the drum is turning but grease is not being removed it may not be dissolving or separating out. If the grease appears hard or crusted, the GGX heater may require inspection or replacement as the grease may not be dissolving under heat.

Emulsified/starchy foods, or soaping problems in the waste flow?

If the surface grease layer is liquid or foam-like in appearance and grease is still not skimming out then it may contain high volumes of dairy waste such as mayonnaise, or starchy waste from rice or pasta. Ensure to reduce volumes of this waste entering the GGX unit. Also ensure to reduce the use of aggressive detergents and do not dispose any bleaching agents into the unit. Only neutral handwashable detergents should be used at the sink. Heavy oven cleaning agents can adversely affect performance if ovens are connected to GGX. Turn the spray wash valve for a few seconds to allow water to break up any crust that formed on the water surface.

Note that at times the unit does not remove any grease because there is only a small layer of grease collected. By design, units will never skim out all the grease and some will always be present on the water surface.

Check the main Lid and Lid-switch

The unit will not operate in cycle with the lid removed. This is a safety feature. With the exception of some maintenance tasks the lid must be fastened in place correctly at all times so that the pushbutton switch is depressed by the lid pressure tab. If this is not the case then the controller display will blink a LID OFF message.

If the message continues to show but the lid seems secure then there may be a fault with the lid switch itself.

PROBLEM: Excessive Water inside the grease collection container

Check Timer Settings

The unit will skim off water if there is little or no grease left in the main tank. Excessive water will typically settle below the grease layer in the collector. Check the timer settings for excessive ON times. The ON time should be scaled back to reduce water being skimmed into the collector.

PROBLEM: Surge Water in grease collector and/or spillages onto floor

In rare cases an obstructed exit from the unit may lead to a water level rise in the main tank which can spill into the grease collector suddenly and in turn onto the floor, if left unchecked.

Ensure the outlet pipe-work from the Grease Guardian is of the right size and at a gravity fall as described earlier. If bends are used, check that these are not blocked and creating an obstruction to the flow.

Ensure that the water flow to the unit does not exceed its rated flow rate.

Ensure that there are no drain line blockages downstream from the unit. Ensure the unit is pumped out at least once quarterly so that sludge does not obstruct the passageways within the main tank.

Do not remove the strainer basket when there is flow entering the unit. Ensure the Strainer is in the correct locked position after each daily maintenance. If not, solids might enter the main tank and obstruct the outlet.

PROBLEM: Sink flow rate is suddenly reduced

Check Strainer Basket

Too much build-up in the strainer basket can effect the sink flow. Ensure that the strainer basket is emptied 1-2 times daily (depending on solids disposed with the wash water) and the screen mesh cleaned. This maintenance frequency should be increased if solids disposal to the grease guardian is excessive. Check also for possible blockages in the inlet flow restrictor.

PROBLEM: Odor reported

Is the smell coming back to the unit from the sewer pipe?

Check that the outlet piping is not allowing smell from the sewer pipe to vent back to the unit. Discuss this problem with your plumber.

Is the outlet pipe properly vented?

To avoid a possible build up of odors in the unit ensure that the outlet pipe is properly ventilated as described earlier in this manual.

Has maintenance been carried out?

Ensure the daily strainer maintenance is carried out. Ensure the tri-monthly pump out is carried out so that any standing sludge at the bottom of the unit is removed before it goes septic. Also seek to prevent any non-skimmable waste from entering the unit as already advised earlier. Scrape visible plate waste to bin rather than rinsing this entirely into the Grease Guardian. This daily basic operation will reduce the build-up of solids and sludge inside the unit.

Stagnant Water

For applications where a connected sink or oven has a very low flow ensure to flush the Grease Guardian unit with fresh water weekly to reduce stagnant water.

COMPONENTS OVERVIEW

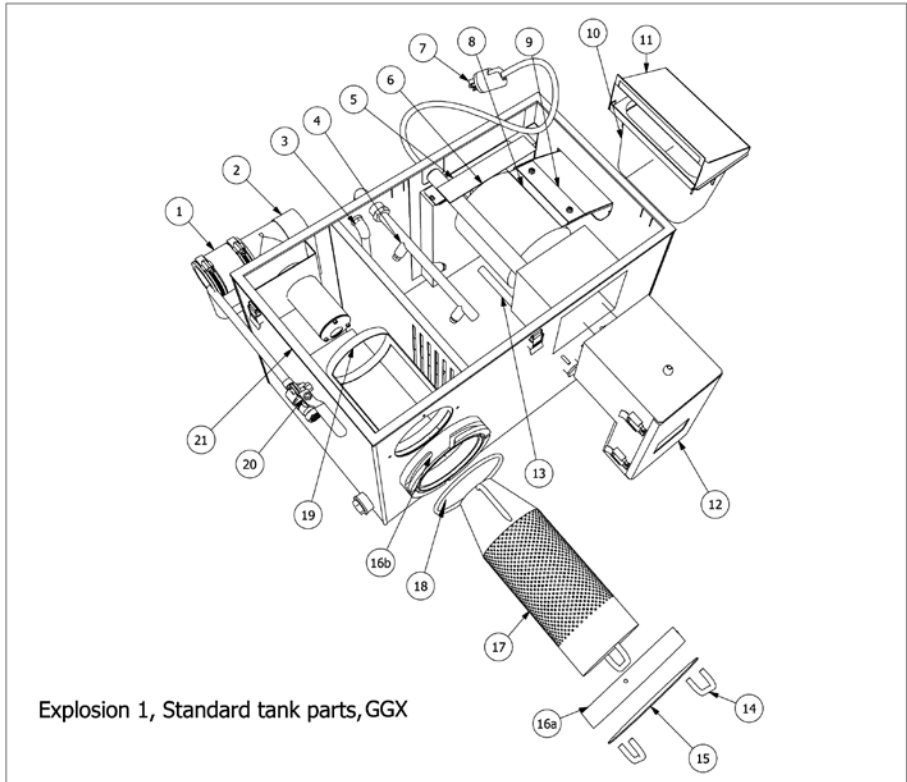

PARTS SCHEDULE

ITEM	DESCRIPTION	
1	Rubber Inlet/Outlet coupler	GGC22/33
2	Rubber Blanking Cap	GGC60END
3	Blower bar	GGXBLRSSBAR
4	Spray bar (Optional)	GGSB
5	Outlet Baffle plate/wheel guard	GGXIP
6	Skimming Drum	GGXSD
7	3 pin Electrical Plug	GGUSPLUG
8	Plastic wiper blade	GGXWBPE
9	Wiper blade Assembly	GGXWBA
10	Grease Collection Container	GGC1
11	Container Bracket	GGXCBN1/4
12	GGX Control Panel	GGXCP
13	Heating Element	GGH110V-600W - GGH240V-1000W
14	Strainer Cap Handles	GGXQTSCH
15	Quarter Turn Strainer Cap Engraved	GGXQTSC
16	Quarter Turn Coupling, 2 part	GGXQT
17	Strainer Basket	GGXS8
18	O Ring	GGXSCORD6MM
19	Strainer Cradle	GGXS8CR
20	Manual Spray Valve	GGVLV1/2
21	Lid Seal Gasket	GGMLG
Option not shown	External Flow Control & Air Intake	GGXFC115

COMPONENTS OVERVIEW

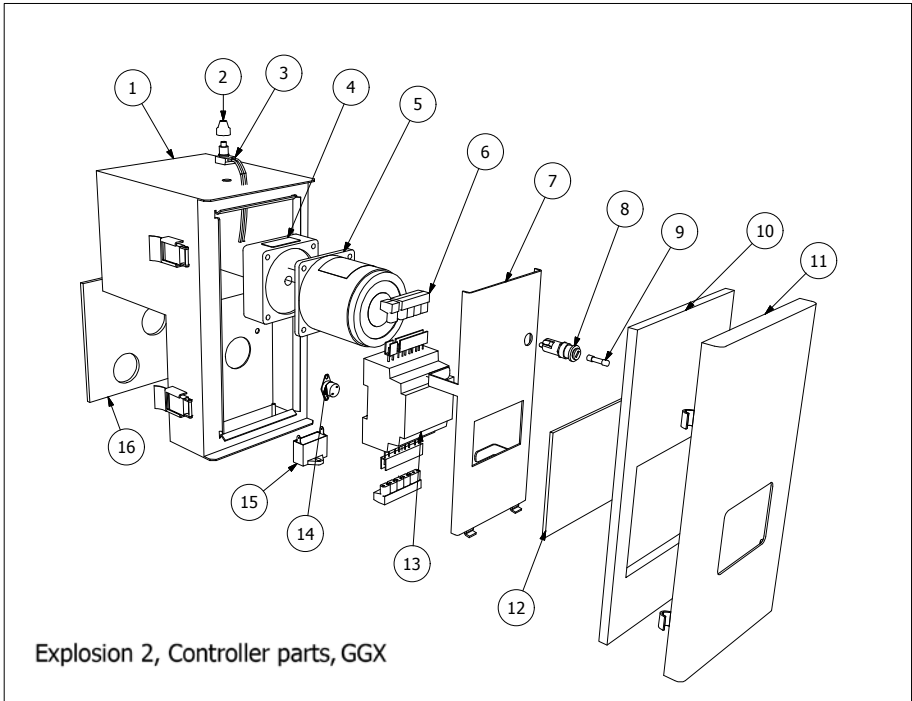

PARTS SCHEDULE

ITEM	DESCRIPTION	
1	GGX Control Panel	GGXCP
2	Magnet for Limit Switch	GGMS
3	Magnetic Switch	GGLM
4	GearBox	GGXGB
5	Drive Motor	GGDM110V-GGDM240V
6	PLC Push Fit Connector set	GGPLCM3CONN
7	Secondary panel cover	GGPC2
8	Fuse Holder*	GGFS
9	Live Fuse	GGF8A - GGF5A
10	GGX Control Panel Gasket	GGXMLGCP
11	Primary Control Panel Cover	GGPC1
12	Perspex viewer	GGPP
13	Micro Controller/PLC	CD12
14	45 Degree C bimetallic thermal switch	GGBIM45
15	Capacitor for Drive Motor	GGCAP110V-GGCAP240V
16	GGX Control Panel Gasket Main Tank	GGXCPRG

*240V units comes with fuse holders

Appendix 1

Wiring diagram (110V)

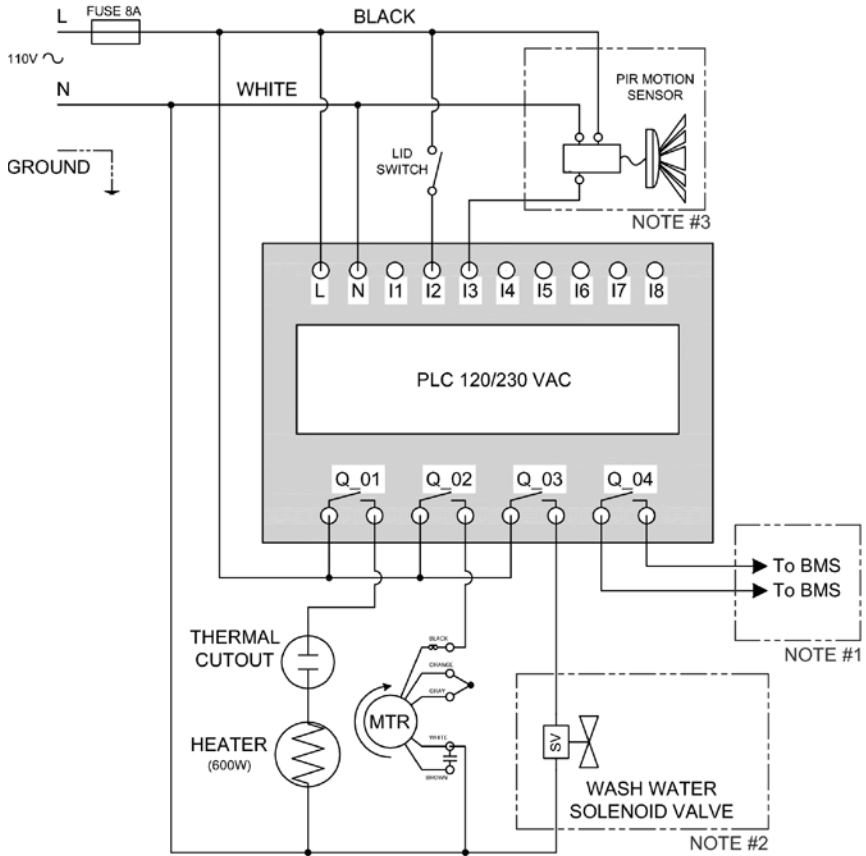

NOTE #1: OPTIONAL - If connecting Output 4 (normally closed contact) to the BMS (Building Management System) ensure that the maximum breaking voltage (5-30VDC, 24-250VAC) and maximum breaking current (8A) are not exceeded

NOTE #2: The washwater valve is standard on GGX7 models only

NOTE #3: OPTIONAL - Motion sensor installation to deactivate operation when not in use

Wiring diagram (230V)

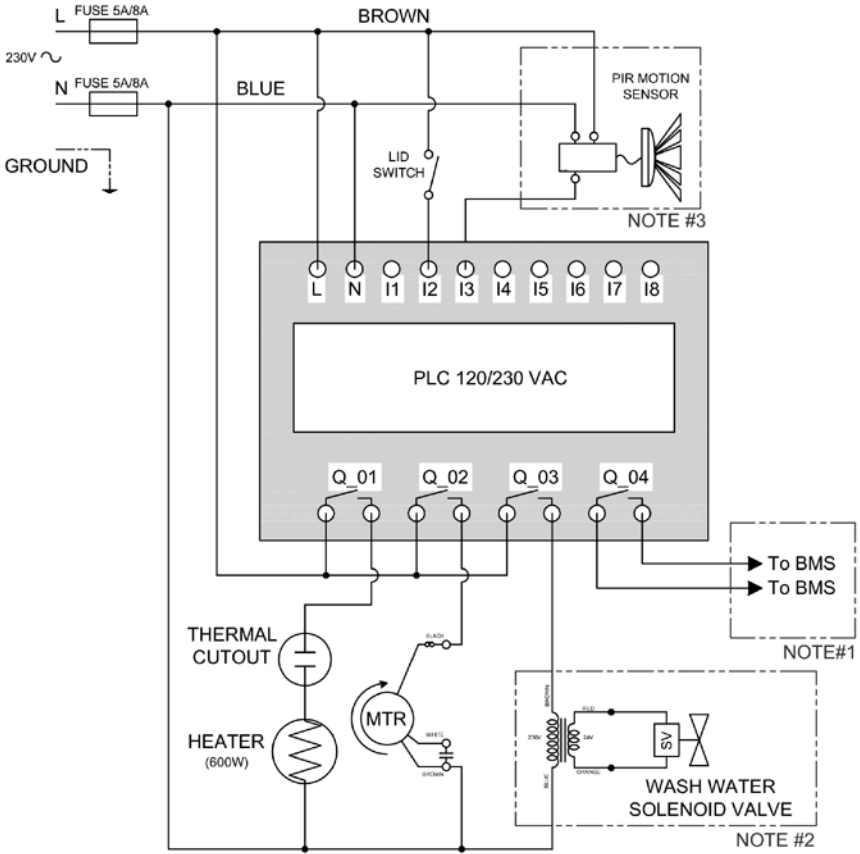

NOTE #1: OPTIONAL - If connecting Output 4 (normally closed contact) to the BMS (Building Management System) ensure that the maximum breaking voltage (5-30VDC, 24-250VAC) and maximum breaking current (8A) are not exceeded

NOTE #2: The washwater valve is standard on GGX7 models only

NOTE #3: OPTIONAL - Motion sensor installation to deactivate operation when not in use

STANDARD WARRANTY

FM Environmental warrants, to the original user, that those products supplied by it and used in the service and in the manner for which they are intended shall be free from defects in materials and workmanship for a period of 1 YEAR.

- a) The warranty period commences from the date goods are dispatched to original user or from the date unit is commissioned provided that commissioning form or other receipt is supplied with claim and that commissioning is carried out within three months of equipment being dispatched.
- b) All warranty claims must be processed through the Dealer from whom the equipment was purchased. The Dealer will co-operate with the purchaser throughout the warranty claims procedure and will arrange any necessary repairs using genuine Grease Guardian parts.
- c) If the original Dealer is no longer able to fulfill their obligations please contact FM Environmental Limited with full details of the claim and proof of purchase or commissioning so that this may be processed without delay.
- d) Any warranty claim can only relate to a specific part that is proven to be at fault and for which a replacement will be supplied but cannot be extended to constitute a claim against the complete appliance.
- e) FM Environmental Ltd will supply the Dealer with any warranty parts required subject to the claim being validated after return of the faulty items.
- f) All replacement parts have a 60 day replacement warranty. Clean defective parts shall be returned, within the warranty period, with proof of purchase, to FM Environmental, transportation charges prepaid, for warranty evaluation. At FM Environmental option, based on the determination of the warranty evaluation, FM Environmental may repair or supply a replacement part from its factory. Any and all items which may be returned shall include the serial number of the unit from which the item was removed, and a return goods authorization number issued by FM Environmental.
- g) This warranty is void if the product has been damaged by its customer prior to acceptance or as a result of unreasonable use, neglect, flooding, alteration, improper installation, improper tri-monthly (4 times yearly) service, maintenance neglect, improper electrical service, installation and/or operation

without timer controls, or other causes not arising out of defects in material or workmanship. Equipment must be installed according to manufacturer's guidelines. This warranty is void if equipment is used in excess of rated flow. FM Environmental products are intended to remove only free floating oils and grease. FM Environmental products do not remove emulsified fats and oils. FM Environmental shall not be responsible for damage to equipment which results from vault flooding, sewer line back-up, pumping or lift station failure, ambient water flow or other sources of water damage. This warranty is void if the serial number on the product has been altered or defaced. FM Environmental will not replace electrical parts which have been installed in under-ground vaults. This warranty is void should use, installation and application be contrary to a written agreement between FM Environmental and the user,

- h) FM Environmental does not make any other representations or warranties, express or implied, including, but not limited to, any implied warranty or merchantability and any implied warranty of fitness or performance for a particular purpose.
- i) The sole and exclusive remedy with respect to the above limited warranty or with respect to any other claim relating to defects or any other condition or use of the product supplied by FM Environmental, however caused, and whether such claim is based upon warranty, contract, negligence, strict liability or any other theory, is LIMITED to the repair or replacement of the part or product, excluding labour or any other cost to remove or install said part or product or, at FM Environmental option, to repayment of the purchase price. Notice of any such claim must be given in writing to FM Environmental within 15 months after the fault installation and / or use of the product
- j) In no event shall FM Environmental be liable for special, direct, indirect, incidental, personal, property or consequential damages, including but not limited to, loss of use or profits or to interruption of business activity. FM Environmental neither assumes nor authorizes any representative or any other person to assume any liability in connection with the sale of its products. FM Environmental makes no warranties, express or implied, with respect to parts, accessories, components or other goods not in FM Environmental scope of supply. Alteration and/or substitution of FM Environmental parts, assemblies, accessories including electrical and/or mechanical components voids FM Environmental warranty.

10 YEAR ANTI - PERFORATION WARRANTY ON THE GREASE GUARDIAN STAINLESS STEEL TANK

FM Environmental warrants, to the original user, that the Grease Guardian main tank supplied and used in the service and in the manner for which it is intended shall be free from defects in materials and workmanship for a period of 10 YEARS. This Warranty is void should the product be damaged by the customer prior to acceptance or as a result of unreasonable use neglect, alteration, improper installation, improper service, maintenance neglect, installation or other causes not arising out of defects in material or workmanship.

The warranty is also void should any of the following conditions exist at any time prior to the defect becoming apparent on the box:

- Salinity level exceeding 1000 ppm
- Chloride level exceeding 250ppm
- pH lower than 6 or greater than 9
- Chlorine levels (from the use of bleach detergents or similar) exceeding 2ppm
- Detergents poured directly into the tank or in high concentrations. The use of bleach (chlorine) and aggressive chemicals when poured in sinks and fixtures discharging into the Grease Guardian is to be limited, and the tank is to be flushed with running tap water for a minimum duration of 5 minutes after these are used in the sinks so to dilute their effect. Detergents are not to be poured directly into the tank.
- Venting not provided on the outlet pipe as per the instructions given, thus inhibiting the venting out of any corrosive gases
- Sludge emptying, if not happening on a regular basis will allow for the accumulation of heavy deposits at the bottom of the tank and these will create corrosion problems. The tank should be emptied, cleaned from sludge and refilled with clean water every 3 months
- Water softeners and reverse osmosis system reject, if allowed to enter the tank will increase the salinity levels of the water and induce corrosion. Reject waters of water softeners and reverse osmosis units have to by-pass the unit and discharge in the discharge pipe after the outlet
- Daily normal water discharge into the unit should not be inhibited, where regular discharge of water from sinks/fixtures should happen for a minimum of 5 minutes daily so as to avoid static water conditions which in themselves might induce corrosion.

Grease Guardian®

X Range



HEAD OFFICE **FM Environmental Ltd**

Greenbank Industrial Estate
Newry, BT34 2QX, N, Ireland

Telephone: +44 [0] 28 302 66616
From ROI Call: 048 302 66616
Fax: +44 [0] 28 302 63233
Email: gg@fmenvironmental.com

www.fmenvironmental.com
www.greaseguardian.com

MALTA OFFICE **FM Environmental [Malta] Ltd**

Water Technology House
A15B Industrial Estate Marsa, Malta

Telephone: +356 2122 6172/3
Fax: +356 2122 6171
Email: fmmalta@fmenvironmental.com

UNITED STATES OFFICE **Grease Guardian LLC**

96 Onondaga Street
Yonkers NY 10704

Telephone: +001 914 375 0902
Mobile: +001 914 316 5671
Email: des@greaseguardian.com

www.greaseguardianusa.com

